

VIVAX
METROTECH









Locators & Supplies, Inc.
(800) 950-6666
sales@locatorsandsupplies.com
www.locatorsandsupplies.com

vLoc3 Series User Handbook
(vLoc3-Pro)
(English Edition)
Version 1.0
P/N: Provisional



Table of Content

1.	General Safety & Care Information.....	1
1.1	Who Can Use This Equipment.....	1
1.2	Work-site Safety.....	1
1.3	Equipment Safety.....	1
1.4	Batteries and Environmental Safety.....	1
1.4.1	Alkaline Batteries (Non Rechargeable).....	1
1.4.2	Nickel Metal Hydride Batteries (Rechargeable).....	1
1.4.3	Lithium-Ion Batteries (Rechargeable).....	2
1.4.4	Lithium Metal Batteries (Non Rechargeable).....	2
1.4.5	General Rules regarding Disposal of Batteries.....	2
1.4.6	Transportation of Lithium-Ion and Lithium-Metal Batteries.....	2
1.5	Care of Equipment.....	2
1.6	Care when Interpreting the Information provided by the Locator.....	3
1.7	American & Canadian Safety Notices.....	3
2.	Service & Support.....	4
2.1	Serial Number and Software Revision Number.....	4
2.2	Distributors and Service Centers Closest to You:.....	5
3.	vLoc3-Pro Receiver.....	6
3.1	vLoc3-Pro Receiver.....	6
3.2	Charging the Receiver Batteries.....	6
3.3	vLoc3-Pro Receiver Keypad.....	7
3.4	User Menu.....	8
3.4.1	About.....	8
3.4.2	Speaker Volume.....	8
3.4.3	Sound Configuration.....	8
3.4.4	Backlight.....	8
3.4.5	Frequency.....	9
3.4.6	Classic Locate.....	9
3.4.7	Locate Perspective.....	9
3.4.8	Language.....	9
3.4.9	Imp/Metric.....	9
3.4.10	Continuous Info.....	9
3.4.11	Auto Power Off.....	9
3.4.12	Warnings.....	9
3.4.13	Bluetooth Pairing (Optional Feature).....	9
3.4.14	Transmitter Link.....	10

3.4.15	Transmitter Control (Only shown as an option if linked with a transmitter)	10
3.4.16	Self-Test	10
3.5	Self-Test	10
3.6	Warnings	10
3.6.1	Signal Overload	10
3.6.2	Shallow Cable	10
3.6.3	Swing Alert	11
3.6.4	Overhead cable	11
3.7	vLoc3-Pro Receiver Locate Screen Shots	11
3.8	Classic Locating Modes (Response)	13
3.8.1	Peak Response Mode 	13
3.8.2	Broad Peak Mode 	13
3.8.3	Null Mode 	14
3.8.4	Delta Null 	14
3.8.5	Peak with Arrows Response Mode 	14
3.8.6	Omni Peak Response Mode 	15
3.9	Information Pushbutton (Depth & Current)	15
4.	Using the vLoc3-Pro	19
4.1	Using the Receiver	19
4.2	Passive Locating	19
4.2.1	Detecting Power Signals	19
4.2.2	Detecting Radio Signals	21
4.3	Active Locating:- Applying the Transmitter	21
4.3.1	Direct Connection	21
4.3.2	Signal Clamp (for frequencies above 8kHz)	23
4.3.3	Induction (for frequencies above 8kHz)	24
4.4	Locating Active Signals	25
4.5	Searching (sweeping) an Area in the Peak Mode	26
4.6	Searching (sweeping) an Area in the Omni Peak Mode	27
4.7	Tracing a Buried Line	27
4.8	Depth & Current Measurement	27
4.9	Distorted Fields	28
4.10	Sonde Location Mode	29
4.11	Signal Direction Precision Identification	30
5.	Data Logging	33
5.1	Bluetooth	34

5.1.1	Fitting the Bluetooth Module	34
5.2	Pairing with external GPS/Dataloggers	34
5.3	Transferring Data from the Locator to a Computer.....	35
5.3.1	MyLocator3.....	35
5.3.2	My Locator3's Basic Operation	36
5.3.3	Toolbar.....	38
5.3.4	Data Logging	38
5.3.5	Splash Screen	39
5.3.6	Frequencies Page.....	40
5.3.7	Menu Settings.....	40
5.3.8	Advanced Features.....	41
6.	Loc-10Tx Transmitter	42
6.1	Loc-10Tx Transmitter Overview	Error! Bookmark not defined.
6.1.1	Display.....	Error! Bookmark not defined.
6.1.2	Pushbuttons.....	Error! Bookmark not defined.
6.1.3	Information Pushbutton.....	Error! Bookmark not defined.
6.1.4	Connections Block	Error! Bookmark not defined.
6.2	Transmitter Battery.....	Error! Bookmark not defined.
6.2.1	Removing the Battery Tray	Error! Bookmark not defined.
6.2.2	Replacing the Alkaline Battery.....	Error! Bookmark not defined.
6.2.3	Rechargeable Batteries	Error! Bookmark not defined.
6.2.4	Re-fitting the Battery Tray.....	Error! Bookmark not defined.
6.2.5	Rechargeable Battery Pack Charging and Disposal	Error! Bookmark not defined.
6.3	Transmitting Modes.....	Error! Bookmark not defined.
6.3.1	Induction Mode	Error! Bookmark not defined.
6.3.2	Direct Connection Mode	Error! Bookmark not defined.
6.3.3	Clamp Mode	Error! Bookmark not defined.
6.4	Frequencies	Error! Bookmark not defined.
6.4.1	Frequencies and Power Output	Error! Bookmark not defined.
6.4.2	Most Used Frequencies (Frequency Selection) Feature.....	Error! Bookmark not defined.
6.4.3	Multi Frequency Mode for Direct Connection.....	Error! Bookmark not defined.
6.5	Remote the Operation of transmitter	Error! Bookmark not defined.
7.	Loc-5STx Transmitter	50
7.1	Loc-5STx Transmitter Overview.....	50
7.1.1	Display.....	50
7.1.2	Pushbuttons.....	51
7.1.3	Information Pushbutton.....	51
7.2	Transmitter Battery.....	51

7.2.1	Removing the Battery Tray	51
7.2.2	Replacing the Alkaline Battery	51
7.2.3	Rechargeable Batteries	52
7.2.4	Re-fitting the Battery Tray	52
7.2.5	Rechargeable Battery Pack Charging and Disposal	52
7.3	Transmitting Modes.....	52
7.3.1	Induction Mode	52
7.3.2	Direct Connection Mode	53
7.3.3	Clamp Mode	54
7.4	Frequencies	54
7.4.1	Frequencies and Power Output	54
7.4.2	Most Used Frequencies (Frequency Selection) Feature.....	55
7.4.3	Multi-Frequency Mode for Direct Connection.....	56
7.5	Transmitter Battery.....	57
7.5.1	Replacing Alkaline Batteries	57
7.5.2	Rechargeable Batteries	57
7.5.3	Battery Charging and Disposal	58
8.	Using the Accessories	59
8.1	Using the LPC Separation Filter.....	59
8.2	Using the Analogue A-frame Fault Finding Accessory	59
8.3	Using the vLoc3-Pro Remote Antenna.....	62
8.4	Using the SD Signal with the Remote Antenna to help trace a particular cable	64
9.	Accessories & Options	67
9.1	A-frame (Optional).....	67
9.2	Remote Antenna (Optional)	67
9.3	Loc-10Tx Vehicle Power Lead (Optional).....	67
9.4	Loc-10Tx Outdoor Power Supply (Optional)	67
9.5	LPC Separation Filter (Optional)	67
9.6	Receiver Vehicle Charging Lead (Optional)	68
9.7	Sonde (Optional).....	68
9.8	Clamp (Optional).....	68
9.9	Clamp Extension Rod	69
9.10	Lithium-ion Rechargeable Battery Pack (Standard)	69
9.11	Receiver Battery Charger (Standard).....	69
9.12	USB Cable (Standard)	69
9.13	Alkaline Battery Holder (Standard).....	69
9.14	Ground Stake (Standard)	70
9.15	Direct Connection Lead (Standard).....	70

9.16	Ground Spool (Optional)	70
9.17	Banana Plugs Adapter (Optional).....	70
9.18	Loc-5STx Battery Pack (NiMH)	70
9.19	Loc-5STx Alkaline Battery Tray.....	70
9.20	Loc-5STx Charger.....	70
9.21	Loc-10Tx Charger	71
9.22	Loc-10Tx Rechargeable Battery Tray	71
9.23	Loc-10Tx Alkaline Battery Tray	71
9.24	Live Plug Connector (LCC)	71
10.	Glossary	72

Provisional

1. General Safety & Care Information

1.1 Who Can Use This Equipment

- This equipment must only be used by people suitably trained in the use of pipe and cable locators.

1.2 Work-site Safety

- Use your company's, or other applicable safety codes and rules when using this equipment.
- Unless having the required authorization, license and appropriate training – **do not** make connections to any pipe, cable or conductor.
- The equipment should not come in contact with corrosive or hazardous chemicals, or gases or dust.
- **Do not** directly connect this equipment to cables or pipes that have a potential difference to ground of greater than 25V AC.

1.3 Equipment Safety

- **Do not** open the enclosures (housings) of either the transmitter or receiver.
- Place the ground stake firmly in the ground before connecting the cable from the transmitter.
- **Do not** hold any uninsulated portion of the connection leads & clips when the transmitter is switched on.

1.4 Batteries and Environmental Safety

Vivax-Metrotech products use four types of batteries:

- Alkaline batteries
- Ni-MH (Nickel Metal Hydride) batteries – rechargeable
- Lithium-Ion batteries – rechargeable
- Lithium-Metal batteries – (small non-rechargeable button cells for “clock” applications)

1.4.1 Alkaline Batteries (Non Rechargeable)

- When replacing the alkaline batteries – use only the size and type specified – **do not** mix battery types (rechargeable and alkaline).
- **Do not** mix partially discharged and fully charged cells in the same battery pack – **do not** mix old with new.
- Never attempt to charge alkaline batteries.

1.4.2 Nickel Metal Hydride Batteries (Rechargeable)

- When using rechargeable batteries, **use only the correct charging device** supplied or specified by the manufacturer. The battery pack or the battery charger will contain circuitry to manage the charging process – other chargers (even if they have the same connector, polarity, voltage & current rating will not have the same control circuitry and can cause damage to the product, overheating, and in extreme cases fire or harm to the individual.
- **Do not** assume that if the plug fits, it is the correct charger – a charger with the correct part number **must** be used – just because it is a Vivax-Metrotech charger, and the plug fits **does not** mean it is the correct charger.
- Before using for the first time, charge rechargeable batteries for six hours. If at any time the rechargeable batteries **do not** last as long as anticipated – discharge fully and then charge for six hours.
- Care should be taken when charging batteries – **Never** repeatedly recharge batteries (or turn power off & on) without using the instrument. If used with an inverter in a vehicle – charge the product then unplug the charger and **do not** charge again until the rechargeable batteries have been used for at least ten minutes. Failure to do this could result in the overcharging of the battery which will shorten the life of the battery and could in some circumstances cause overheating or fire.
- If ever the product becomes hot during the charging process, **immediately** unplug the charger and use the rechargeable batteries for at least ten minutes before recharging. If this reoccurs the next time the unit is

1 General Safety & Care Information

charged – return immediately to Vivax-Metrotech for repair.

- **Do not** charge batteries for prolonged periods of time without using the locator for at least ten minutes. Charging for prolonged period of time could overcharge the battery, reduce the battery life and in extreme circumstances cause damage to the locator and fire.

1.4.3 Lithium-Ion Batteries (Rechargeable)

- Lithium-Ion Batteries – some products use Lithium-Ion batteries – the requirements for marking and transportation are still developing. Please contact Vivax-Metrotech before shipping products containing Lithium-Ion batteries or Lithium-Ion battery packs on their own for any “special instructions”.

1.4.4 Lithium Metal Batteries (Non Rechargeable)

- Commonly known as “button cells” these are small – non-rechargeable batteries used to power internal “clocks” within some units (similar to computers). Generally, they have a life of three to five years.
- Under no circumstances should any attempt be made to charge these batteries.
- Dispose of to your company’s work practice/environmental standards, the prevailing laws, or recognized best practice. Always dispose of batteries responsibly.

1.4.5 General Rules regarding Disposal of Batteries

- **Never** disassemble a battery, or battery pack.
- **Never** dispose of in a fire or water.
- Dispose of batteries in accordance with your company’s work practice/environmental standards, the prevailing laws, or recognized best practice. Always dispose of batteries responsibly.

1.4.6 Transportation of Lithium-Ion and Lithium-Metal Batteries

- The Lithium-Ion and Lithium-Metal batteries used in Vivax-Metrotech products meet the required safety standards and include the designated protection circuitry.
- Recent regulation changes require that when batteries with Lithium-Ion and Lithium-Metal batteries are transported, the packaging **must** include specified warning labels.
- **Please contact Vivax-Metrotech Customer Service (USA 1-800-446-3392, International +1-408-734-1400 (USA Pacific Time Zone)) for more details.**
- Regulations have also changed regarding the shipping of spare battery packs (battery packs that are not inside a product). There are limitations on the weight of the package, and the packaging must be marked with the appropriate warning labels.
- **Please contact Vivax-Metrotech Customer Service (USA 1-800-446-3392, International +1-408-734-1400 (USA Pacific Time Zone)) for more details.**
- Vivax-Metrotech vLoc Series 2 products using Lithium-Ion battery are classified as “not restricted” they can be shipped normally by road/rail/sea & air (passenger & freight aircraft) without restrictions.



IMPORTANT

Remember – Batteries contain dangerous chemicals – They can be affected by many things such as water ingress or heat – In some circumstances they can explode. They also can cause electric shocks!

1.5 Care of Equipment

- Use equipment only as directed in this User Handbook.
- **Do not** immerse any part of this equipment in water.
- Store in a dry place.
- Keep equipment in the case provided when not in use.
- If left for prolonged period of time – remove alkaline batteries.
- Keep unit clean and free of dust and dirt.
- Protect against excessive heat.

1 General Safety & Care Information

1.6 **Care when Interpreting the Information provided by the Locator**

- Like all locators – this instrument is locating and providing depth and current readings based on electromagnetic signals that radiate from the buried cable or pipe. In most cases these signals will enable the locator to pinpoint both position depth and current correctly.
- **Beware** – in some cases other factors will distort electromagnetic fields radiating from cable or pipe being located, resulting in incorrect information.
- Always locate responsibly and use information learned during your training to interpret the information provided by the locator.
- **Do not** provide information regarding depth of cable or pipe to anyone unless authorized to do so by your company.
- **Remember** that depth measurements are to the center of the electromagnetic field or pipe – In the case of pipes this may be significantly deeper than the top of the pipe.

1.7 **American & Canadian Safety Notices**

USA

- This transmitter and receiver comply with the general conditions of operation, pursuant to part 15 of the FCC Rules.
 - CFR 47 Part 2
 - CFR 47 Part 15
- Changes or modifications not expressly approved by the manufacturer could void the user's authority to operate the products.

CANADA

- Equipment is for use by trained operators only, and not for general household or consumer use.
- Operation is subject to the following two conditions: (1) this device may not cause interference, and (2) this device must accept any interference that may cause undesired operation of the device.

EUROPE

- Vivax-Metrotech confirms that the location system is compliant with relevant provision of European directive 1999/5/EC.
 - EN 55011
 - EN 61000-4-2: A1 & A2
 - EN 61000-4-3
 - EN 61000-4-8: A1
 - ETSI EN 300 330-2
 - ETSI EN 301 489-1
 - ETSI EN 301 489-3

2. Service & Support

2.1 Serial Number and Software Revision Number

Always quote your receiver and transmitter model number, serial number and software revision number when requesting product support. They can be found as follows: (for reference only)



1	Model & Serial Number
---	-----------------------

NOTE

The transmitter Model & Serial Number can be found at the bottom of the transmitter and also inside the transmitter between the battery tray and the main module of transmitter.



Software Revision Number: On both receiver and transmitter the software revision number is displayed on the LCD during the start up sequence or can be found in the “About” section of the user menu.

2.2 Distributors and Service Centers Closest to You:

World Headquarters, United State of America	Central/South America and the Caribbean
Vivax-Metrotech Corporation 3251 Olcott Street, Santa Clara, CA 95054, USA Website : www.vivax-metrotech.com Sales & Sales Support: T/Free : 800-446-3392 Tel : +1-408-734-1400 Fax : +1-408-734-1415 Email : sales@vxmt.com Service & Repairs: T/Free : 800-638-7682 Tel : +1-408-962-9990 Fax : +1-408-734-1799 Email : service@vxmt.com	Ventas para América Latina 3251 Olcott Street, Santa Clara, CA 95054, USA T/Free : 800-624-6210 Tel : +1-408-734-1400 Fax : +1-408-743-5597 Website : www.vivax-metrotech.com Email : VentasparaAmericaLatina@vxmt.com China Leidi Utility Supply (Shanghai) Ltd. No. 780, Tianshan Rd, Shanghai, China 200051 T/Free : 4008-206-719 Tel : +86-21-5235-3001 Fax : +86-21-5235-8365 Website : www.leidi.cn Email : info@leidi.cn
Australasia	France
Vivax-Metrotech AUS Unit 1, 176 South Creek Road, Cromer NSW 2099, Australia Tel : +61-2-9972-9244 Fax : +61-2-9972-9433 Website : www.vivax-metrotech.com.au Email : sales@vxmtaus.com service@vxmtaus.com	Vivax-Metrotech SAS Technoparc - 1 allée du Moulin Berger, 69130 Ecully, France Tel : +33(0)4 72 53 03 03 Fax : +33(0)4 72 53 03 13 Website : www.vivax-metrotech.com Email : salesfrance@vxmt.com
Canada	United Kingdom
Vivax Canada Inc. 41 Courtland Ave Unit 6, Vaughan, ON L4K 3T3, Canada Tel : +1-289-846-3010 Fax : +1-905-752-0214 Website : www.vivax-metrotech.com Email : CanadianSales@vxmt.com	Vivax-Metrotech Ltd. Unit 18-19, Woodside Road, South Marston Industrial Estate, Swindon, SN3 4WA, UK Free Phone: 0800 0281811 Tel : +44(0)1793 822679 Website : www.vivax-metrotech.com Email : salesUK@vxmt.com
Germany	
Metrotech Vertriebs GmbH Am steinernen Kreuz 10a D-96110 Schesslitz Tel : +49 954 277 227 43 Email : serviceGermany@vxmt.com	

3. vLoc3-Pro Receiver

3.1 vLoc3-Pro Receiver

The vLoc3-Pro is a Precision Location System designed to meet the needs of utility companies and their contractors. The following describes the features and use of the receiver.

vLoc3-Pro Receiver main connectors:



1	Pushbutton & Display	5	Mini-USB Port Data Transfer and Software Upgrade
2	Model number# & Serial number#	6	Battery compartment cover
3	Battery retaining cover	7	Accessory socket and charging point
4	AA Alkaline Battery Pack/Rechargeable Battery Pack	8	Expansion sockets for additional features such as the blue tooth module

3.2 Charging the Receiver Batteries

The vLoc3-Pro can be used with either alkaline batteries or it can be supplied with an interchangeable rechargeable battery pack.



The central illuminated section within the battery icon indicates the amount of charge remaining.

- Blue center indicates alkaline batteries
- Green center indicates rechargeable batteries
- When batteries are low the charge remaining section becomes red and will flash

Just before shutdown the following symbol will be shown:



Rechargeable batteries are supplied with a mains charger. This is specific to the batteries, avoid the use of other manufacturers' chargers as these may damage the battery pack and may result in overheating of the battery pack.

3 vLoc3-Pro Receiver

To charge the rechargeable batteries, first make sure the pack is inserted in the receiver battery compartment as charging is done with the battery inside the receiver.



Connect the charger to the charging/accessory socket of the receiver. Connect charger to the mains and switch on. The LED indicator on the charger will illuminate red until the batteries are fully charged at which time the LED will change to green.



WARNING

Rechargeable batteries are supplied with a mains or 12V DC charger. These are specific to the batteries. Only use the charger that is appropriate for the batteries in the product. If in doubt, call the Vivax-Metrotech customer service department at +1(800) 446-3392. Failure to use the appropriate charger could result in damage to the battery pack, locator and in extreme cases cause fire.

Avoid charging the unit in extreme temperature conditions. (i.e. below 0°C and above 45°C)

Although Vivax-Metrotech batteries include all the required safety related features, immediately discontinue use of the charger and battery pack if the battery pack becomes excessively warm. Return both to where they were purchased for investigation.

Always ensure batteries have at least a partial charge if storing for long periods without use.

Dispose of all batteries in accordance with your company procedures and Federal/State and local regulations.

Never dismantle batteries, put them in fire, or get wet.

3.3 vLoc3-Pro Receiver Keypad

Keypad:

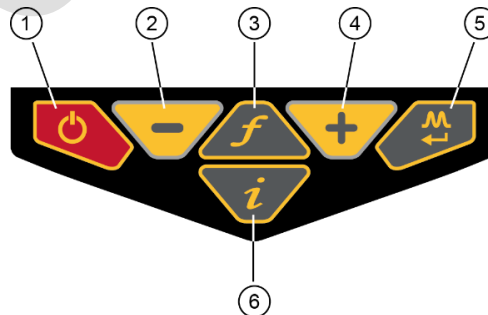

1	On/Off	4	Select frequency
2	Reduce sensitivity. (Also scroll up when in User Menu)	5	Short press = change antenna response Long press = change operational screen
3	Increase sensitivity. (Also scroll down when in User Menu)	6	Short press = enter information screen Long press = enter User Set-up options

3.4 User Menu

The vLoc3-Pro has several features that can be switched on and off. These features are accessed through the user menu.

Switch on the unit by pressing and holding the On/Off key until the start-up screen appears. The start-up screen can be configured to the user's preference and is described later in the manual. Otherwise the start-up screen will default to the one below:



Access to the User Menu is via the "i" button. Press and hold down the button until the menu appears.

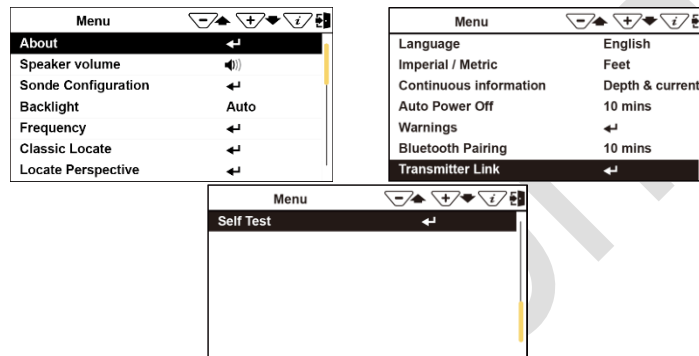

Main Menu

Note that the manual shows three screens but only one is shown on the vLoc3-Pro display at a time.

Note that where you see this sign  it means that pressing the enter button gives access to the sub-menu associated with this button.

To exit the menu or sub-menu, press the "i" button.

Where the  icon is not shown, the enter button is used to scroll through the options of that feature.

Use the "+" and "-" buttons to scroll up and down through the menu.

The features are described below:

3.4.1 About

This section holds the data about the locator such as software revision, calibration data etc.

3.4.2 Speaker Volume

Press the enter button to scroll through the speaker volume settings

3.4.3 Sound Configuration

Allows configuration of sounds generated in locate modes

- Active mode:
 - Frequency Modulated (FM) Sound pitch changes with signal strength
 - Amplitude Modulated (AM) Sound volume changes with signal strength
- Radio mode: FM or Real (Sound derived directly from received signal)
- Power mode: FM or Real

3.4.4 Backlight

Press the enter button to change the backlight intensity setting. Note that high backlight setting will affect battery life. Or select "Auto" which automatically sets backlight depending on ambient light levels.

3.4.5 Frequency

Use the enter key to enter the Frequency sub-menu. Scroll up and down the table using the “+” and “-” keys. The table contains all available frequency options. To simplify the operation of the unit, select only the frequencies applicable to your application. To do this use the enter key to check the boxes on the right. Frequencies not checked will not appear of the locate screen.

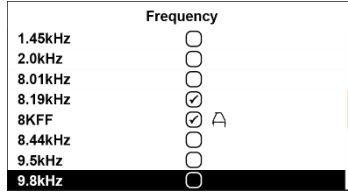

Note also that certain frequency options have an A-frame icon next to them. This indicates that these frequencies are selected to be used with the fault find A-frame.

3.4.6 Classic Locate

This option is only shown if the User menu is entered from the Classic Screen.

Use the enter key to reveal the list of options relating to the Classic Locate modes. Options are:

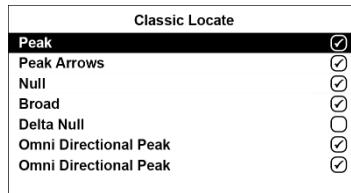

3.4.7 Locate Perspective

Enter this option to be able to select in what graphical format the data is displayed. These displays are described further in the manual. The options are:

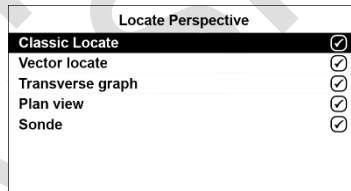

3.4.8 Language

The unit may be supplied with different language options. Use the enter key to select the language of choice.

3.4.9 Imp/Metric

Select either Imperial or Metric measurements

3.4.10 Continuous Info

The front Locate Screen can display a continuous reading of either depth, current, both or can be switched off. Use the enter button to select your preference.

3.4.11 Auto Power Off

The unit can be set to switch off after a set time. Options are: 5 minutes, 10 minutes, or never. Note that when the A-frame is connected the timer is set to “Never”.

3.4.12 Warnings

Warnings relating to: - Shallow cable, Overload, Overhead cable and Signal Overload. Scroll down to the relevant warning and use the return button to select or de-select.

3.4.13 Bluetooth Pairing (Optional Feature)

Press the enter button to enter the Bluetooth pairing routine. This allows the unit to link with external devices such as dataloggers and GPS devices that have Bluetooth capability.

3.4.14 Transmitter Link

Enter the sub-menu to enable or disable the transmitter link. The link is used to control certain features of the transmitter from the locator. (Factory fit option)

3.4.15 Transmitter Control (Only shown as an option if linked with a transmitter)

Enter the sub-menu to gain information relating to the transmitter link status. For more information, refer to section 6 relating to Loc3-10Tx. (Factory fit option)

3.4.16 Self-Test

Pressing the enter key will initiate a series of self-tests. If any of the tests fail repeat the test in a more interference free site i.e. away from fluorescent lights, power signal sources etc. If the unit continues to fail, the unit should be returned to Vivax-Metrotech Corp or one of its authorised service centres for repair.

3.5 Self-Test

The vLoc3-Pro has a self-test feature. The test confirms that the equipment is fit for use and calibration has not drifted from its expected settings.

To undertake the test, first find an area free from excessive interference such as overhead fluorescent lighting, large transformers etc. Also check that any nearby vLoc transmitters are switched off.

Select "Self-Test" from the user menu and press the "Return" button. The test will self-start. Keep the equipment stationary while the test is completed. After a short while the unit will report a Pass or Fail. Examples are below:



If the unit fails the test, try again in a more interference free area. If it continues to fail, return the unit to Vivax-Metrotech or one of its approved repair centers for investigation and repair

3.6 Warnings

Warnings are displayed in real time across the display as below:

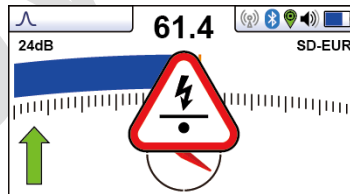

3.6.1 Signal Overload



This is a very unusual situation and is usually caused by operating VERY close to a power transformer or placing the unit very close to a transmitter in the Induction mode. Moving slightly away from the interfering signal will cure the problem. Signal overload will not cause damage to the instrument.

3.6.2 Shallow Cable



This indicates that the locator has detected a cable that is possibly less than 15cm deep. Proceed with caution.

3.6.3 Swing Alert



This indicates that the operator is swinging the locator excessively and could result in misleading information. When sweeping the locator across the direction of the line, try to keep it vertical. This will improve accuracy.

3.6.4 Overhead cable



This indicates that the signal is mainly radiating from above. This is usually caused by the signal travelling along overhead cables.

The warning symbols are accompanied by an audible sound and a vibration in the handle unless configured otherwise (See MyLocator3). Warnings can also be switched off in the User Set-up Menu.

3.7 vLoc3-Pro Receiver Locate Screen Shots

The user interface of the vLoc3-Pro is under continual development. The screen shots described may differ slightly from current screens.

The vLoc3-Pro gives the user a choice of different locate screens. The choice of screen depends on application and user preference.

- Classic Screen
- Vector Screen
- Plan view Screen
- Transverse Plot Screen

This manual will first explain the functions of the “Classic Screen” as familiarity of this screen will help understand the functions of the others.

An overview of the Classic Screen

Classic Screen:

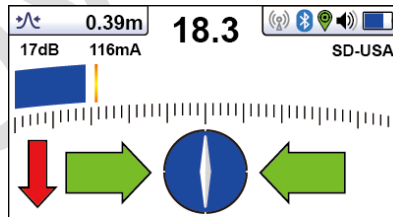

Status bar:

All the screens have a status bar at the top which indicates various settings of the locator. The bar is shown below:

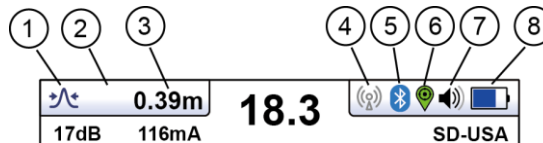

1	Antenna configuration (meter response) described later in the manual
2	This icon is shown in this position when the sonde locate screen is selected
3	Depth to target line. (Can also be set to display signal current on line or both)
4	Radio link to transmitter status
5	Blue tooth status

3 vLoc3-Pro Receiver

6	GPS status
7	Speaker volume setting
8	Battery type and remaining charge

The Classic Screen has all the functions normally seen on a classic cable locator. The main functions being:

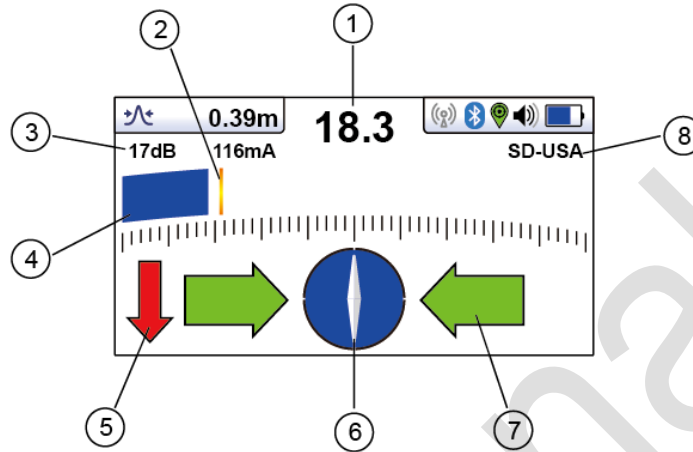

1	Percentage signal strength (Mirrors the bar graph setting)
2	Peak level indicator
3	Gain setting
4	Bar graph signal strength indicator (Changes colour depending on distortion level) Green: - low distortion. Blue: - Minor distortion, proceed with care. Red: - Excessive distortion, treat all data and measurements with caution.
5	Signal Direction forward/back arrows (Only active with Signal Direction frequencies)
6	Compass line direction indicator (Turns blue when aligned with target line)
7	Left/Right direction to target line indicators
8	Frequency selection (Flashing frequency indicates frequency selection is not valid for this screen. Choose another frequency)

Tip:







When in a locate screen, pressing and holding the “f” key will bring up the frequency table.

Radio
SD-EUR
8kHz
8KFF
33kHz
83kHz
200kHz

Use the “+” and “-” keys to navigate quickly to the desired frequency. Press the “i” key to select a highlighted choice and return to the locate screen.

Screen Icons explained

Classic Screen/Antenna configurations:

Icon	Description	Function/response
	Peak	Dual horizontal antennas giving largest signal over the line with sharp accurate results. Less affected by distorted signals.
	Null	Vertical antenna giving minimum signal over the line with sharp response but more affected by distorted signals. Can be used to identify distorted signals by comparing results with the peak mode.
	Broad peak	Uses single antenna. Not so accurate as dual peak antennas and more difficult to pinpoint the line but gives a signal boost from deep lines.
	Delta-Null	Uses dual null antennas to minimise the offset effects of field distortion. This mode tends to be more precise than the Null mode.
	Peak with Arrows	Same bar graph response as Peak but Left/Right Arrows indicate the Null locate position. Good, general purpose mode, giving quick intuitive results.
	Omni direction	When you see the two double ended arrows around an icon, this means that the line is detectable regardless of locator blade orientation. It is very useful for quickly checking an area for buried lines.

3.8 Classic Locating Modes (Response)

The vLoc3-Pro receiver has an array of six antennas, and these can be toggled through different configurations (modes) to provide different responses to the signals radiating from buried utilities. The modes are:

3.8.1 Peak Response Mode 

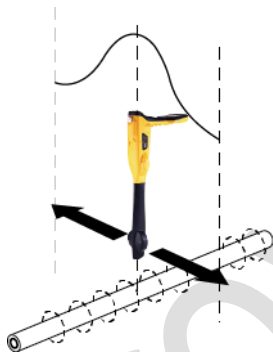

Two horizontal antennas provide a “Peak” or maximum signal response over the center of the buried line. The compass (line direction indicator) aligns itself parallel to the direction of the cable (available in Active modes).

This is an accurate method of the locating as both horizontal antennas are used to provide a clearly identifiable “Peak”. It is also less prone to the effects of signal distortion.

A Peak Level Indicator is also provided on the bar graph. This indicates the largest signal detected allowing the user to quickly return to this point.

3.8.2 Broad Peak Mode 

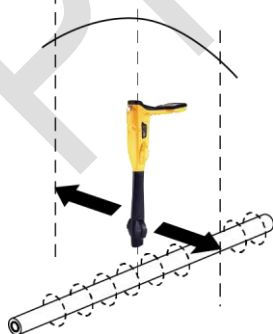

This uses a single horizontal antenna and provides a “Peak” or maximum signal response over the center of the buried line. The compass (line direction indicator) aligns itself parallel to the direction of the cable (available in Active modes).

This gives a less defined peak than the twin horizontal antenna “Peak” mode – but is useful in some situations such as deep lines because using a single antenna has the effect of boosting the received signal.

3.8.3 Null Mode

This uses vertical antennas, and provides a minimum or “Null” response over the center of the buried line.

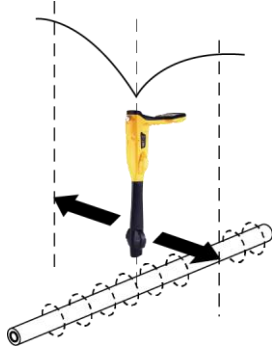

The compass (line direction indicator) aligns itself parallel to the direction of the cable (available in Active modes)

The null mode works well in uncongested areas but is more prone to inaccuracies due to the effects of field distortion. This effect can be utilised to detect the presence of distorted fields. Compare the locate position “Null Mode” with the position “Peak Mode”. If the two positions do not coincide, this indicates possible distortion. The greater the difference the greater the distortion.

Left/right indication arrows are also displayed when in “Null” mode. The arrows indicate the direction to move the receiver to locate the position of the buried line.

3.8.4 Delta Null

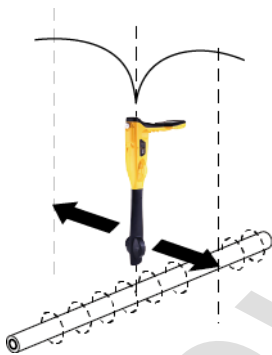

This uses dual vertical antennas. This has the advantage that it provides a sharper response than the “null” mode and is less affected by distorted fields. All other functions are the same as the “Null” mode.

3.8.5 Peak with Arrows Response Mode

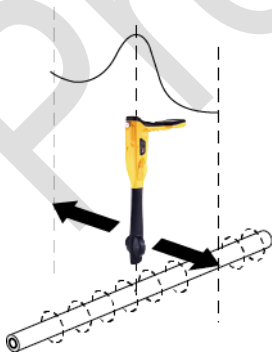

The peak with arrows mode operates in the same way as the peak mode. It gives the largest meter deflection when directly over the line. However, left/right indication arrows are also displayed. The arrows indicate the direction to move the receiver to locate the position of the buried line.

Note:

If the arrows indicated a different position for the cable than the peak bar graph position, this indicates the possibility of a distorted field. Check by taking a depth reading on the ground and then lift the cable locator a known distance such as 1m (3ft). If the depth does not increase by this amount it confirms a distorted field and the data should be treated with caution.

3.8.6 Omni Peak Response Mode

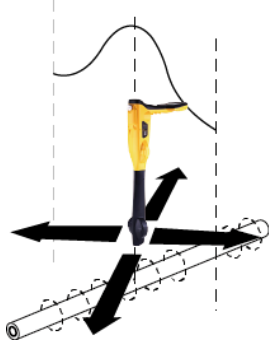

When you see the two double ended arrows around an icon, this means that the line is detectable regardless of locator blade orientation. It is very useful for quickly checking an area for buried lines using a grid search as one sweep will catch all locatable lines. In the classic screen the Omni feature is available in the “Peak” and “Broad peak” modes.

3.9 Information Pushbutton (Depth & Current)

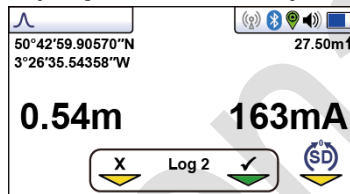

When in a Locate screen, a quick press of the “i” (information) pushbutton will display the depth and signal current.

The display shown above shows Longitude/Latitude positional information. To the top right is the height above sea level. This is only displayed when the equipment is paired with a valid GPS system and a valid signal is received.

It is also possible to save the data to the internal memory. This is explained in detail in the “Datalogging” section.



IMPORTANT





When locating a cable or pipe (“Line”) – depth and current measurements should only be taken with the bottom of the receiver standing on the ground and directly in line with the target line. Unless the  Omni direction mode is selected in which case orientation is not important.

The accuracy of depth and current readings depends on the quality of the radiated signal being located. If the signal is symmetrical (undistorted), the depth reading will be accurate to within 5% of the actual depth. If the signal is distorted, depth readings will be less accurate. When taking depth measurement, always hold the receiver at 90° to the ground.

Alternative Locate Screens

As previously mentioned, the vLoc3-Pro has a number of alternative screens. The following section describes operation these screens. It is left to the user to decide which is the best screen for a particular application.

To scroll through the available screens, use long key presses on the “return” key.

	Sonde	Specific mode for detecting and locating sonde transmitters.
	Vector configuration	Shows a cross section of the ground and line position relative to the locator.
	Plan view	Gives a plan view as if looking into the ground.
	Trans. Graph	Shows a graphical representation of the peak and null field shape over a line (Active modes only) Good for analysing signal distortion.

Vector Screen

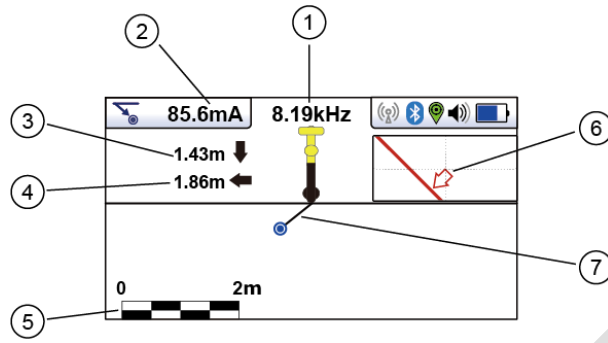

1	Frequency selected	5	Scaling (adjust with +/- keys)
2	Signal current	6	Shows plan view of target
3	Vertical distance to target	7	Cross section view that shows vectors to target
4	Horizontal distance to target		

Using the Vector screen

1. Apply the signal to the target line in the usual way and select the vector screen by using long presses on the “return” button until the desired screen appears.
2. Position the locator within the approximate position of the target line. Use the plan view to help guide you towards the target line. You can imagine that the plan view is giving you a view into the ground.
3. Position yourself so that the red target line is pointing forward/back and is centralized on the screen.



4. If the target is off the screen an arrow will appear on the screen to help direct you to the target line.

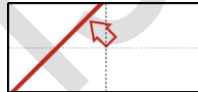

5. The cross-sectional section of the screen will respond as the target is approached. Use the + and – keys to alter the scaling if necessary.
6. There is a black line leading from the locator to the target line. The target is represented by a blue dot. Around the dot is a circle, the size of the circle indicates a confidence factor. The larger the circle the less confident the indicated position. Generally, the actual position of the line will be within the confidence circle.

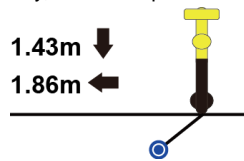

The color of the confidence circle also changes depending on the degree of confidence:

Green: - low distortion/high confidence.

Blue: - Minor distortion/medium confidence, proceed with care.

Red: - Excessive distortion/low confidence, treat all data and measurements with caution.

7. Notice that vertical and horizontal distances from the target line are displayed.

1.43m ↓
1.86m ←

This must not be mistaken for the distance diagonally to the target, this information is not displayed. The vertical distance is the true depth from the bottom of the locator. The advantage of this is that the depth and position of the target can be determined without being directly over the target line. So, in the event of an obstruction at the measuring point, data can still be gathered by placing the locator to one side of the target.

Plan View Screen

The plan view screen shows a picture as if you were viewing the line from above ground. When the red line is in the center and pointing forward/back then you are directly over the line and pointing in the direction of the line.

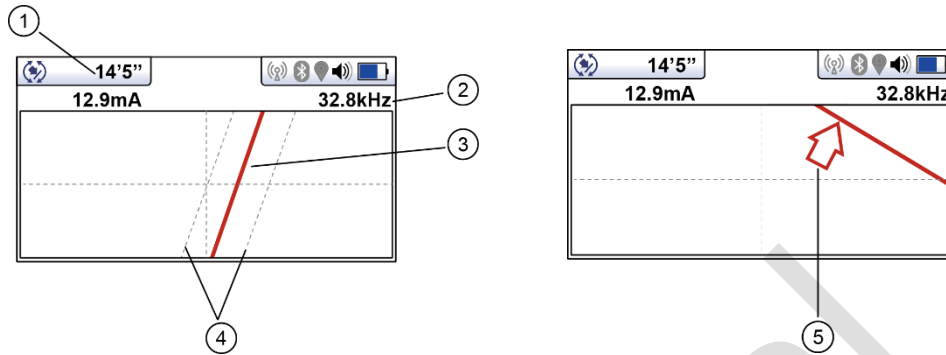

1	Depth and current readings
2	Frequency selected
3	Target line
4	Lines of confidence (Closer these are to the target line indicates more confidence)
5	Arrow indicates direction to move towards line, it only shows when the distance to the target line is far away.

Using the Plan View screen.

1. Apply the signal to the target line in the usual way and select the plan view screen by using long presses on the return button until the desired screen appears.
2. Position the locator within the approximate position of the target line. Use the plan view to help guide you towards the target line. You can imagine that the plan view is giving you a view into the ground.
3. Position yourself so that the target line is pointing forward/back and is centralized on the screen.

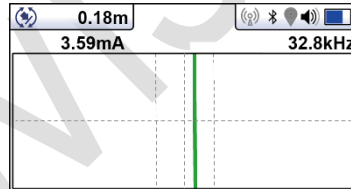

“Tram” lines either side of the line indicate an area of confidence. The closer the tram lines are together the greater the confidence.

In addition to the tram lines, the color of the target line also changes depending on the degree of confidence:

Green: - low distortion/high confidence.

Blue: - Minor distortion/medium confidence, proceed with care.

Red: - Excessive distortion/low confidence, treat all data and measurements with caution.

4. If the target is off the screen an arrow will appear on the screen to help direct you to the target line.

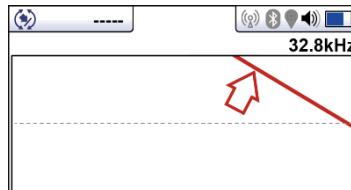

5. As long as the locator is detecting a valid signal, the depth (or current) will be available regardless of locator orientation i.e. the locator does not need to be aligned with the target line in the forward back orientation. It is recommended that, in this mode, the current is always displayed as it is possible signal will bleed off onto other services. Regular checks on the signal current i.e. checking for large changes, will ensure the correct line is detected.

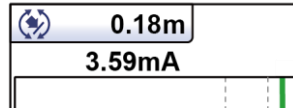

6. A short press on the info button will display the information screen. More information relating to the information screen is described in a previous section "Information Pushbutton (Depth & Current)".

Transverse Plot Screen

The Transverse Plot screen is used to analyze the field shape at a particular location. This enables the user to get a better feel for the reliability of the data gathered.

Two plots are generated simultaneously.

- Peak response
- Null response

In non-distorted fields, the peak and null positions should coincide and the shape of the fields should be symmetrical about the center line. The picture below shows a slightly distorted field.

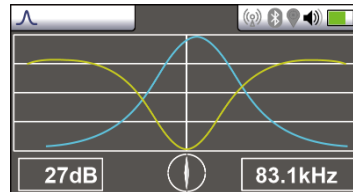

To take a plot first locate the target using one of the other locate screens. Now select the Transverse screen by a prolonged press of the return button. Repeat this until the Transverse screen appears.

Position yourself to one side of the line such that the field markers are just on the screen. You will see that the lines automatically remove themselves after a set period of a few seconds. Clear the screen by pressing the “-” button. Now walk across the line of the target at a steady pace until you are on the other side of the target line. Immediately press the “+” button to save the plot on the screen.

It is still possible to walk back over the target, locating the position of the line when in the transverse screen while still retaining the saved screen.

4. Using the vLoc3-Pro

4.1 Using the Receiver

Line Locating (Using the "Classic" Screen)

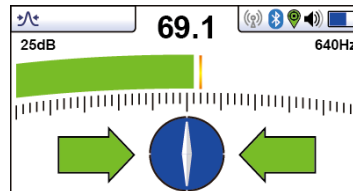

4.2 Passive Locating



NOTE

The compass indicator is not active during passive location.

Passive locating refers to the process of detecting signals that "naturally" occur on pipes and cables. These tend to fall into two categories, radio signals and power signals.

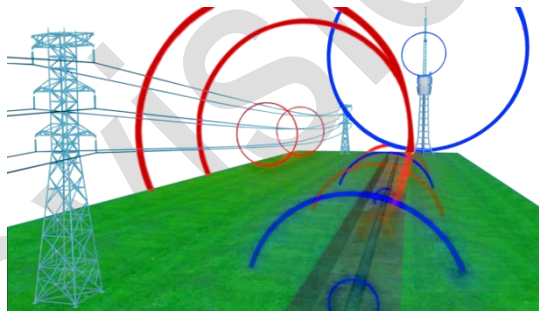

Radio signals are created by low frequency radio transmitters. These are used for broadcasting and communications. They are positioned throughout the world. As the frequencies are very low the signals tend to penetrate and hug the curvature of the earth. When the signals cross a long conductor such as a pipe or cable, the signals are re-radiated. It is these re-radiated signals that can be detected by the Radio mode.

Power signals are created by mains power running in the supply cables. These signals are 50 or 60Hz depending on country. For instance, the UK is 50Hz power but in the USA has 60Hz. When electrical power is distributed throughout the network, some of the power finds its way back to the power station via the ground. These stray currents can jump onto pipes and cables and also create power signals. Note that there has to be electrical current flowing to create a detectable signal. For instance, a live cable that is not in use may not radiate a detectable signal. Also, a very well balanced cable, ie exactly the same current flowing in live and neutral, will cancel out and may not create a signal. In practice this is unusual as there is usually enough imbalances in the cable to create a good detectable signal.

4.2.1 Detecting Power Signals

1. Switch on the vLoc3-Pro receiver and select Power mode using the "f" button. Notice that the antenna mode indicator will be showing "Peak" or "Omni peak" as these are the only options in the passive modes.

4 Using the vLoc3-Pro

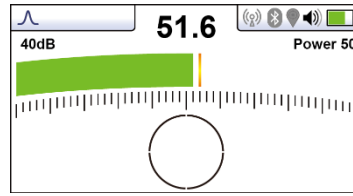

2. Hold the vLoc3-Pro vertically and away from likely positions of cables or pipes.
3. Adjust the sensitivity using the “+” and “-” buttons so that the bar graph reading is just starting to show some movement. Note that the compass feature is not available for the Power or Radio modes.



NOTE

Note that there will be no sound from the speaker until the meter reading is above approximately 10% of full scale.

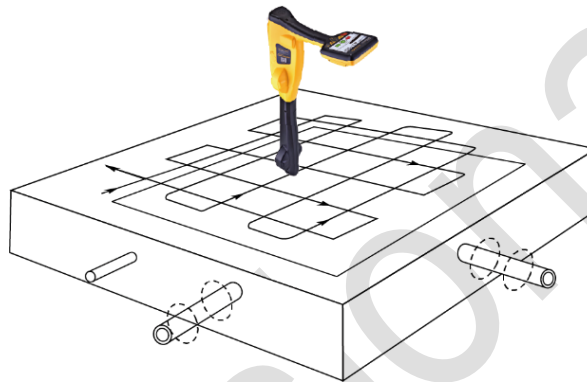

4. Keeping the vLoc3-Pro vertical, walk across the area to be checked keeping the orientation so that the blade is in line with the direction of walking. (See diagram above) If using the Onmi Peak mode the orientation of the locator is not important.
5. Continue in a grid across the area.
6. If at any time, the meter reading starts to increase, carefully move the locator side to side to detect the maximum signal. Use the peak level indicator to help confirm the correct position.

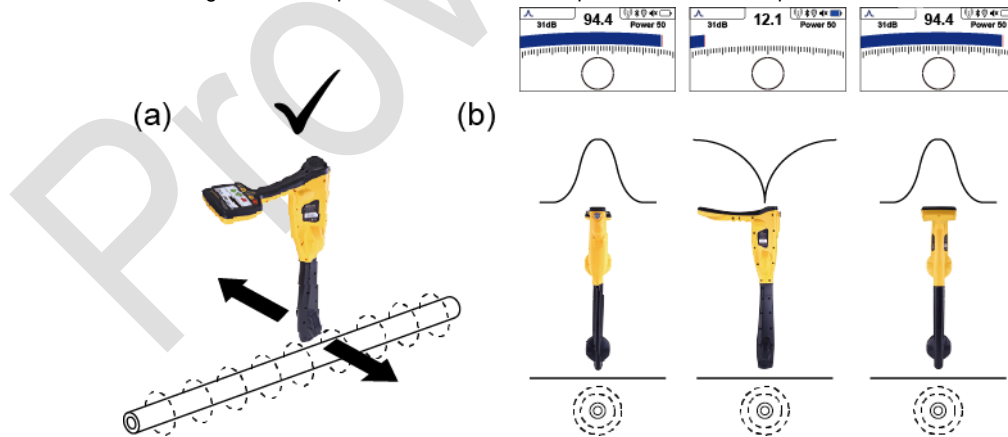

7. Rotate the vLoc3-Pro on its axis to obtain the maximum signal. The vLoc3-Pro is now directly over the line and with the blade across the line. (If using the Omi peak mode there will be no change so switch to Peak mode if the direction is required)
8. The direction can also be found by rotating until the smallest signal is detected. The blade is then in line with the cable/pipe.
9. Continue to locate the position of the line at regular intervals until its course is known through the target area.

4.2.2 Detecting Radio Signals

1. Locating radio signals is very similar to detecting power signals as they are both passive signals.
2. Hold the vLoc3-Pro vertically and away from likely positions of cables or pipes.
3. Adjust the sensitivity control so that the bar graph reading is just starting to show some movement. Now follow the procedure described above in the power mode section.

4.3 Active Locating:- Applying the Transmitter

Active locating uses a transmitter to apply a precise frequency to a pipe or cable, then uses a receiver turned to detect the signal being radiated at that precise frequency. Active location frequencies can be applied by direct connection, signal clamp or induction. (This is further explained in the following sections)

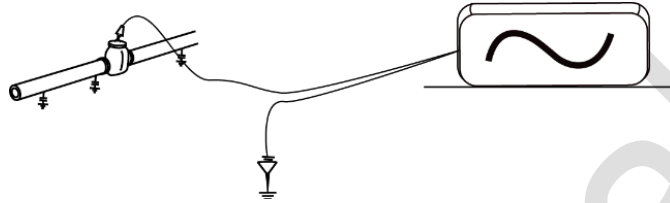

Active locating has the benefit that, unlike passive detecting, the operator is in control of the signals and therefore can be more specific about what line is detected. That is to say active signals can be used for line tracing. Also, passive signals are not always present on a line so using active signals ensures more lines are detected.

Choosing the correct frequency will depend on the application but as a general rule, select low frequencies as these tend to “bleed off” less than higher frequencies. A good general-purpose frequency is 33kHz and is a good starting point if in doubt.

When using “Induction” or the “signal clamp”, the frequencies available are limited to a set of frequencies optimised for the equipment. The full range of frequencies is available in “Direct connection” mode.

For frequencies below 45 kHz, authorities such as the FCC allow higher power output to be used; for frequencies of 45 kHz and above, power output for this type of equipment is restricted to 1 watt. Therefore more power is available when lower frequencies are used.

To inject a signal requires the use of a transmitter. The signal can be injected or applied to the target line in a variety of ways.

4.3.1 Direct Connection

This method involves making an electrical connection to the cable or pipe.



WARNING

When connecting to a cable, only connect to the sheath of that cable. The direct connection leads are not designed for connection to live cables.

WARNING

Do not touch metal parts of the connection clips when connecting to the line or when the transmitter is on.

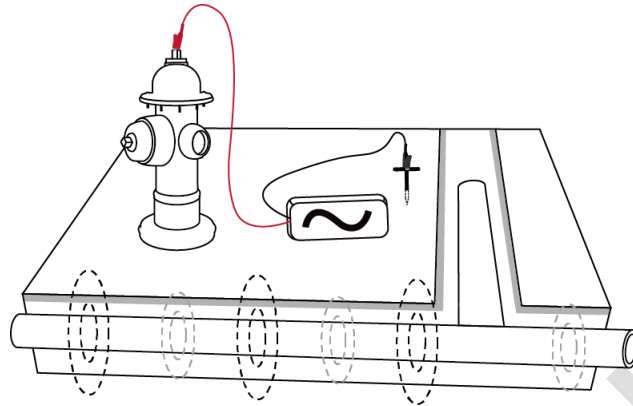

WARNING

Only authorized personnel should make connections to cables.

To make a direct connection, insert the direct connection connector to the transmitter. Insert the ground stake into the ground a few meters perpendicular to the line. Connect the black lead to the ground stake. Now take the red lead and connect to the target line.

Switch on the transmitter by pressing and holding the on/off button down for a couple of seconds. Select the desired frequency depending on the application. Check for a good connection by either noting the mA output on the display or noting the change in tone rate when disconnecting and then reconnecting the red lead. (Depending on transmitter model)

Things that can affect the quality of connection are:

1. Rusty pipe connection point: clean the connection area with a wire brush.
2. Poor grounding: try inserting the stake into damp ground. Dampen the surrounding ground with water. If still an issue, try connecting to a manhole cover surround. Avoid connecting to fence railings as these may create return signal currents along the fencing that will interfere with the locating signal.

Always start with a low output and increase the output if the received signal is not strong enough. Setting the output to high when it is not required may result in some of the signal "bleeding off" onto other services and will drain more power than necessary from the battery.

When connecting to a ferrous material, it is sometimes not possible to find a suitable projection to apply the connection clip. If this is the case, use the optional magnet to make contact to the line and then clip the red clip to the magnet. A good example of this is to make a connection to a street lighting circuit. Usually it is the practice to connect the sheath of a lighting cable to the metallic inspection cover of a street lamp. Making a connection to the inspection plate will energize the cable via the plate and sheath. Usually there is no projection on the plate on which to clip, so using the magnet on the plate provides a suitable clipping point.

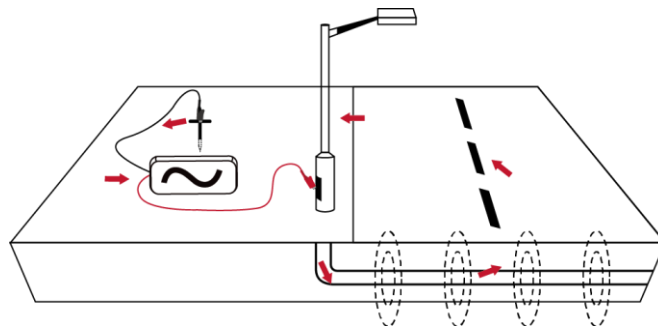

4.3.2 Signal Clamp (for frequencies above 8kHz)

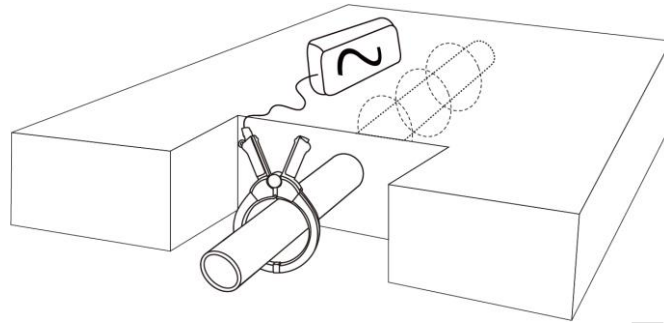

In many situations, it is not possible to gain access to a cable to make an electrical contact. Or if there is, it is not safe to do so. The signal clamp provides an efficient and safe method of applying a locate signal to a cable.

Note that for best results the cable should be grounded at both ends. The clamp should be fully closed for optimal current induction. A small amount of current will still be induced if the jaws are open.

When clamping around a cable make sure the clamp is placed below the grounding point as shown below.

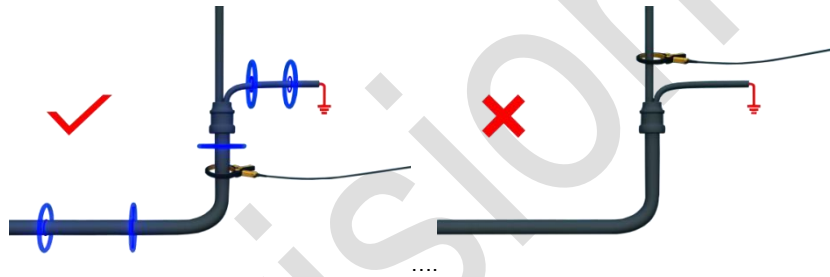

When applying a clamp close to a grounding point where multiple grounds or a grounding bus exists, ensure that you place the clamp around the target line and not to the ground bus/other grounds. This will help focus the applied signal to the target line.

Clamp Extension Rod

A useful accessory to the clamp is the extension rod:

Male thread for screwing into a clamp

Yellow handle (removable) /female thread for connecting to another extension rod



The extension rod is fitted with a 10mm threaded male stud. This male thread screws into the handle of the signal clamp to extend the distance of the clamp. This is helpful in areas with difficult access such as in manholes or overhead cables. (Not to be used on uninsulated overhead power cables.)

The extension rod is also fitted with a female thread in the handle which enables the rods to be fitted together to further extend the range. To access this thread, slide the yellow handle off the rod.

To operate the clamp jaws when attached to the rod, gently pull on the clamp cord which will open the jaws. Release cable to close them.



WARNING

ALWAYS follow the appropriate safety requirements mandated by safety legislation, safety practice or your company's safety procedures when applying a clamp (coupler) to a cable.



BEWARE that when placing a clamp around cables carrying high current, the clamp may vibrate, jump or close violently due to inducted current from the target cable.

In some situations, high voltages can be induced back onto the clamp and be present at clamp's plug. Safety practices should be followed all times when clamping around live target lines!

In all situations ensure the clamp is connected to the transmitter before clamping around a line.

4.3.3 Induction (for frequencies above 8kHz)

With no direct connection lead or signal clamp connected, the transmitter will automatically start to radiate a signal around the transmitter. These signals will penetrate the ground and couple onto buried lines. The signal will then travel along the line which can be detected with the vLoc3-Pro locator.

Applying an induction signal to a line.

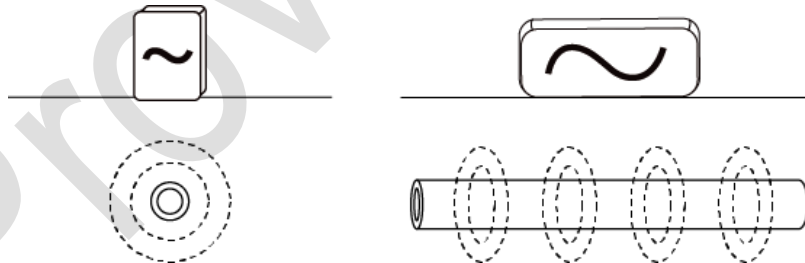

Remove any connections from the output connector. Switch on the transmitter and place it over the suspected position of the line and position it so that it is in line of the target as above. In the case of the Loc3-10Tx that is with the handle pointing along the line and in the case of the Loc-5STx arrows printed on the labels should point along the line of the target line.

The induction mode is particularly useful where there is no access to the line, but it should be noted that this is the least efficient method of applying a signal and it is also prone to signals being applied to adjacent lines.

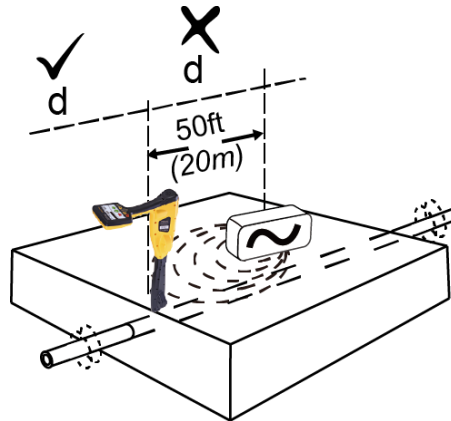

Also note that the signal will radiate out to the side of the transmitter as well as below. For this reason, it is recommended that when applying a signal using the induction method, a distance of at least 20m is kept from the transmitter when pinpointing or taking depth readings. Locating closer than 20m is possible but the operator should be aware that the signal directly received from the transmitter may be strong enough to influence the results.

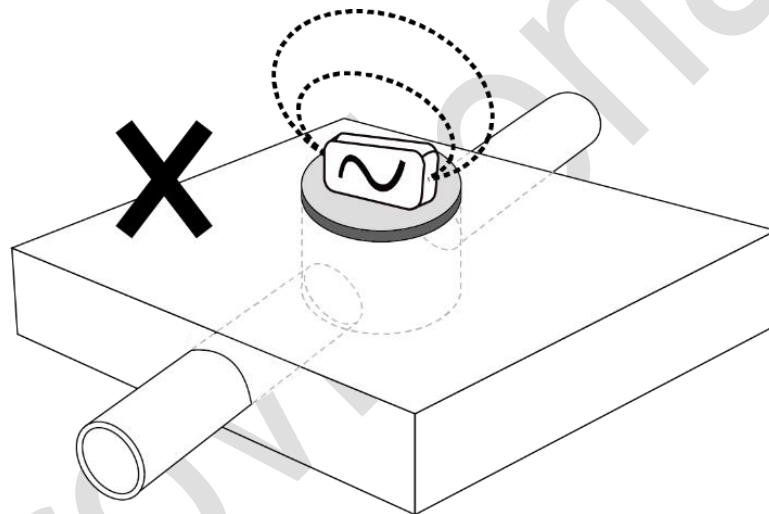

When using the induction mode, avoid placing the transmitter over metallic manhole covers as this will severely reduce the effectiveness of the transmitter and in extreme cases cause damage to the transmitter's circuitry

4.4 Locating Active Signals

These instructions assume that the Classic Screen is selected and Peak with Arrows mode is selected for the antenna configuration.

Apply an active signal to a line using one of the methods outlined above in section 4.3, active locating. Set the antenna configuration to "Peak with arrows".

Switch on the receiver and select a desired locate frequency matching the transmitter setting.

Note that the screen will now show the addition of a compass (line direction indicator). In the presence of a locate signal the compass will align itself parallel to the line being located. This ensures that the operator is aware of the direction of the line.

4 Using the vLoc3-Pro

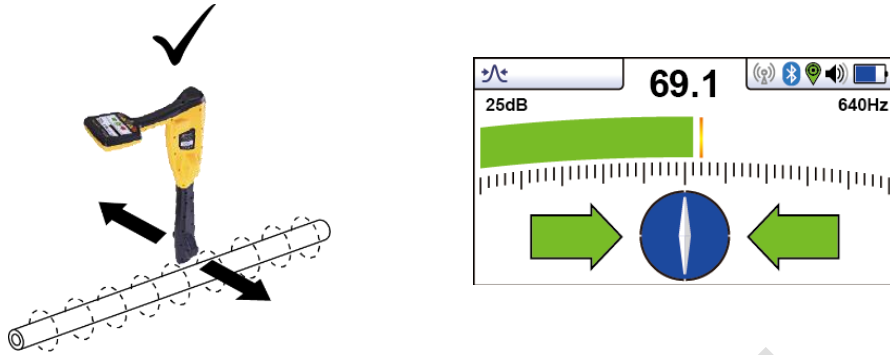

Hold the locator vertically and rotate it on its axis until the compass indicates Forward/Back as above.

Adjust the sensitivity control so that the display indicates approximately 50%. Keeping the vLoc3-Pro vertical, move to the side slightly. If the bar graph increases, you are moving toward the line. If it decreases, you are walking away from it. Move toward the line as indicated by the direction arrows, until a maximum signal is achieved. It may be necessary to reduce the sensitivity to keep the bar graph on scale. This is normal and should be expected. Try to keep the vLoc3-Pro vertical and avoid swinging it as this may create false readings.

Move the locator side to side to ensure a maximum signal is detected. Use the peak level indicator to assist.

With the maximum signal found and the compass running Forward/Back, the vLoc3-Pro is now directly over the line and exactly across it.

If the signal is not distorted, the position of maximum signal will coincide with the position as indicated by the arrows. If these two positions do not agree, it may be because there is signal distortion. Treat the results with caution.

Continue to trace the line to its destination or source.

Note that if you have selected "Omni Peak" antenna configuration, arrows will not appear either side of the Compass. This is because the line can be detected from any direction in the Omni mode.

4.5 Searching (sweeping) an Area in the Peak Mode

In any given area, it is likely that buried pipes and cables are not parallel to each other, frequently they will cross the area being searched at a variety of different angles and depths. As the response of locator antennas is directional (using the traditional screen), it is important to search the area in the same or similar pattern as below. This orients the antennas in a way that will locate any signals being radiate from the buried line. Once a response is found, then trace and pinpoint the line and mark. Searching an area in this way is generally (but not exclusively) done in the "Peak" mode using passive locating.

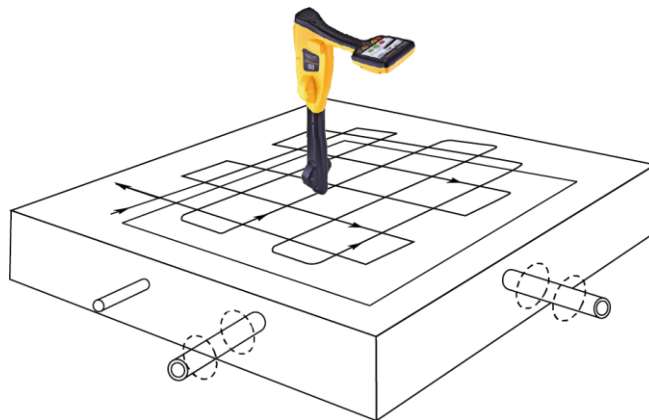

4.6 Searching (sweeping) an Area in the Omni Peak Mode

Searching an area with Omni antennas is very similar to the above except that it is only necessary to sweep an area in one direction. That is to say a zig zag motion is enough rather than a full grid action. This is because the locator will respond to a signal from a line in any direction. It has the benefit of cutting the sweep time in half.

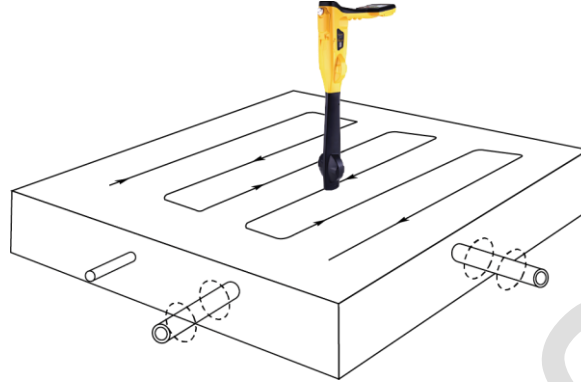

4.7 Tracing a Buried Line

Where possible trace out from the transmitter connection point. Having “pinpointed” the line, hold the locator vertically and in front of you with the compass line indicator pointing forward/back. Start by moving the locator left to right/right to left over the line. Keep the movement over the centre of the line i.e. the largest meter response, adjusting the gain when necessary. Whenever practical it should be traced to a point that provides additional confirmation of what type of service is being located (i.e. a telephone pedestal, a manhole cover etc.).

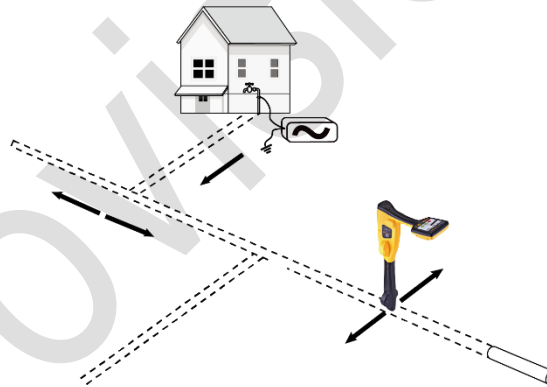

4.8 Depth & Current Measurement

If the depth measurement feature is activated, it is possible to take depth measurement estimations. To take a depth measurement, first pinpoint the position of the line as above. Place the tip of the vLoc3-Pro on the ground making sure it is vertical and across the line i.e. the compass indicating Forward/Back. Momentarily press the “i” button. The screen will change to a screen similar to the one below.

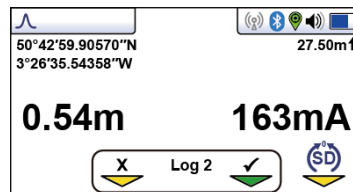

Note that if Omni mode is selected the orientation of the locator is not important but it is still necessary to pinpoint the line accurately before taking a depth measurement.

4 Using the vLoc3-Pro

The signal current value will also be displayed. This feature is useful for confirming that the detected signal is radiating from the correct line. In the event the signal is "bleeding off" onto other services, these signals will generally be less than that of the originating signal. However, care should be taken as the signal current will gradually reduce over the length of the line, but watching for a sudden drop in current over distance should indicate that either:

1. There is a ground fault on the line which is shunting signal to ground.
2. There is a "T" off from the mainline.
3. The operator has migrated from the connected line to a line which has some signal that has bled across from the main line.

4.9 Distorted Fields

When locating, always be aware that you are locating the signals radiating from the buried line, these radiated fields, as they are called, can be distorted by other lines or electromagnetic signals from buried lines or metallic features like crash barriers or wire mesh fences.

As seen previously, the vLoc3-Pro has the ability to detect the presence of possible distortion i.e. the Vector screen has a circle drawn around the target line which increases in size in the presence of possible distortion, and the Plan view screen has "Tram" lines either side of the calculated position which move further from the line as more possible distortion is detected. However, when using the traditional screen, the risk of an inaccurate location can be reduced further by the following:

- Check to see if the signal is being distorted by other radiated fields. Locate the cable, first in the "Peak" mode, and then in the "Null" mode (or use the left/rightly arrows). The two locations should indicate that the cable is in the same place. If they do not, the signal field is distorted, and the depth and current measurement may be inaccurate.

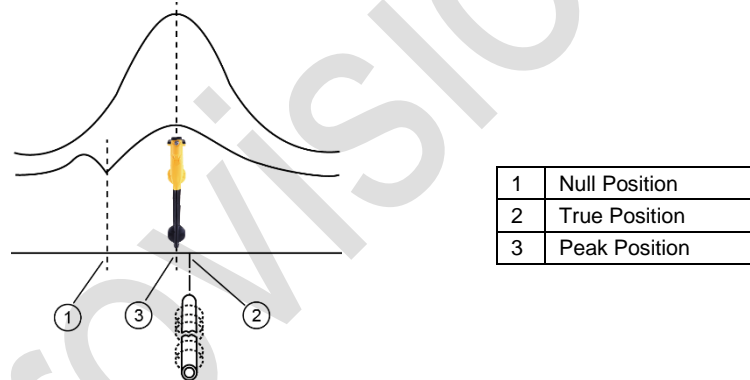

- Measure the depth of the buried line by pressing "i" pushbutton briefly to measure depth and current. The depth should be approximately in line with the "as built" plans available. If no plans are available logic would still help to assess the situation (for instance, if you are looking for a shallow CCTV distribution cable and the depth indicated is 5ft (1.5m) it should raise a concern).
- Take a depth reading on the ground and then raise the locator approximately 1ft or 0.25m and repeat the depth measurement. The depth should increase by this amount, if not treat the information with caution.
- A depth reading on congested areas or close to bends or tee's maybe inaccurate due to distorted fields.

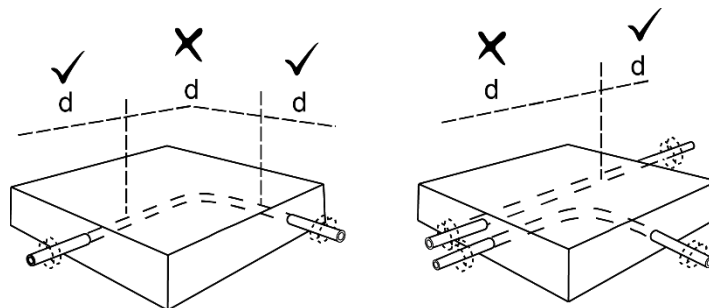

4.10 Sonde Location Mode

A Sonde is typically used for locating non-metallic pipes or ducts, and the camera end of a sewer inspection camera. Low frequency versions (512Hz/640Hz) can transmit through some metallic pipes such as cast iron pipes – which is why they are frequently used with sewer inspection cameras.

Sonde screen icons:

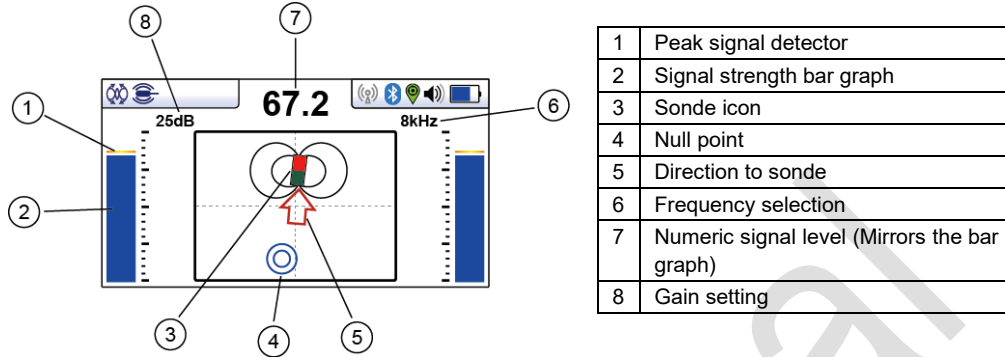

A Sonde is a transmitting coil, the signal radiates in a different manner than that of a line.

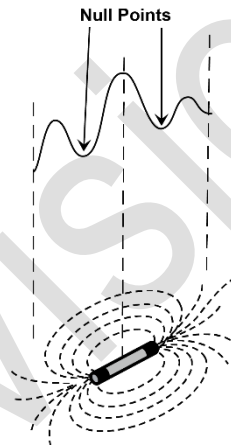

Due to this construction, the sonde gives a different “Peak” pattern note that there are three distinct peaks – a small peak – a large peak – a small peak with two “Nulls” between the peaks. The sonde is located under the center of the “large peak”

The vLoc3-Pro detects the presence of the two “Null” signals and also the position of the main “Large Peak”. It uses this information to provide a reliable and efficient method of sonde location.

Method

1. Insert the activated sonde into the pipeline. Push the sonde about 10 – 12 Feet (3-4m) into the pipe.
2. Switch on the vLoc3-Pro and use long presses on the Return key until the sonde screen appears.



3. Press the “f” key to select the sonde frequency being used.
4. Hold the locator vertically and stationary with the tip on the ground.
5. If the locator is within the range of the sonde the screen will appear similar to the one below with an arrow pointing in a particular and steady direction. The bar graphs either side of the screen are identical and give an indication of the signal strength. Use the + and – keys to alter the receiver gain to keep the signal within the limits of the bar graph.

4 Using the vLoc3-Pro

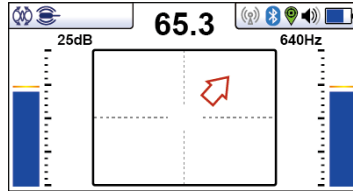

6. If the bar graph is not steady it will most likely be because the sonde is not within range. In this case hold the locator at approximately 45 degrees to the ground and rotate the locator around a full 360 degrees around you.

Note the direction of strongest signal and walk towards it until the bar graph shows a steady signal. Now revert to step five above.

7. Walk slowly in the direction of the arrow.
8. A double circle will appear on the screen. This indicates the position of a null signal. Walk towards it and position it over the cross hairs of the screen. Now rotate the locator so that the arrow is pointing forwards.

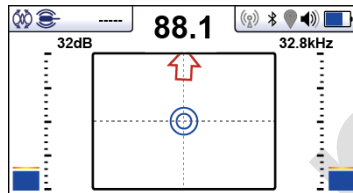

9. Keeping the null indicator on the vertical line, walk toward the arrow.
10. A Sonde icon will soon appear. Keeping the locator vertical, carry on walking toward the Sonde until it is positioned on the cross hairs. The locator is now directly over the Sonde. The arrow will flip forward and back as the position is crossed.

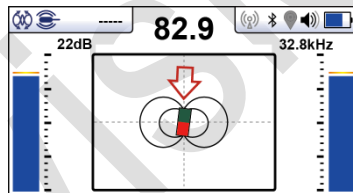

11. Note that when directly over the Sonde, it may be necessary to confirm the position of the Sonde, left to right. To do this move the locator left to right to identify the position of the strongest signal as indicated on the bar graph. At this time the depth to the Sonde will be displayed at the top of the display.
12. Having pinpointed the position of the Sonde, it can now be pushed in to a new location and the process repeated. It is advisable to keep the survey intervals to short distances such as six feet (two meters) as this makes the process of locating easier.
13. Pressing the Information key allows access measurement data and to data logging capabilities.

4.11 Signal Direction Precision Identification

(Available for vLoc3-Pro with SD and vLoc3-ML models only)

Some models in the vLoc series of locators contain a feature called "SIGNAL DIRECTION". This feature is used to verify if the line being located is the target to which the transmitter has been connected.

When a transmitter is connected to a target line, the signal travels along it and finds the easiest way to travel back, usually via the ground and ground stake. However, very often the signal will travel back along adjacent cables or pipes as these can offer an easier route.

As a result, there can be multiple signals radiating from cables and pipes in the area making it difficult to identify the target line. These return signals are typically traveling in the opposite direction than the applied signal. The Signal Direction feature identifies which direction the signal is flowing and hence the target line.

4 Using the vLoc3-Pro

To use the signal direction system:

- Connect the transmitter to the target line using a direct connection only.

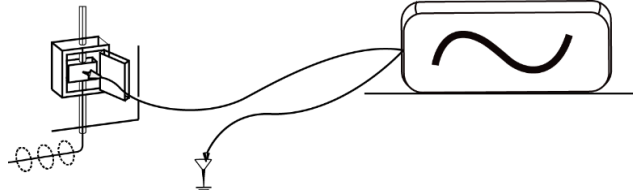

- Turn the transmitter and receiver on, and set both to:
 - SD-USA – if in North America or any territory where the power system is 60Hz.
 - SD-EUR – if in Europe or any territory where the power system is 50Hz.
- Locate the cable. The receiver may, or may not be flashing the “SD” Forward/Back arrows icon
- A flashing SD arrow indicates that the unit needs to be synchronized with the transmitter. Even if the arrow is not flashing it is always good practice to synchronize the system at the beginning of a survey to ensure reliable results and to maximize the distance to the next synchronization point.
- To synchronize the receiver to the transmitter at the beginning of a survey, pinpoint the line very close to the transmitter – be sure that it is the correct line. Then, standing facing away from where the transmitter is attached, press the “i” pushbutton. The unit will now display the information screen showing the depth of line, signal current and a “SD” icon positioned over the return pushbutton. Pressing the return pushbutton will synchronize the system and return the unit to the locate screen. The green forward arrow will light and not be flashing indicating the receiver is locked onto the signal. The system is now synchronized.

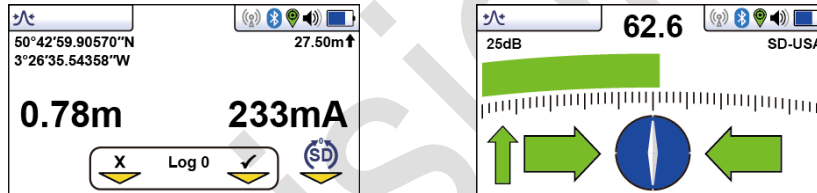

- Proceed to locate, trace, pinpoint as required ensuring at all times the green forward arrow is illuminated. If at any time the red backward arrow illuminates, this indicates that the wrong line is being located.

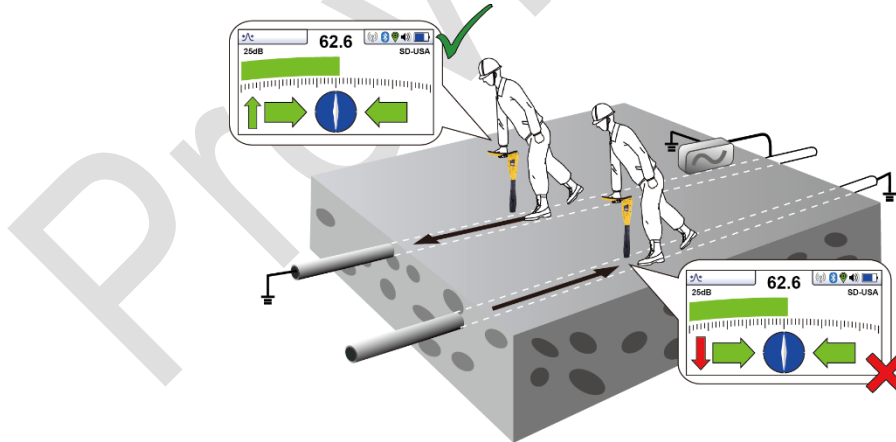

- At some point, you may find that the SD arrow starts to flash – this is indicating that synchronization with the transmitter has deteriorated and a reset is required.

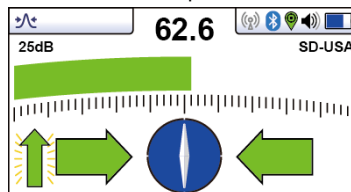

4 Using the vLoc3-Pro

- Re-trace your line back to a point where a solid signal direction is obtained. Precisely pinpoint the line and stand with your back to the direction of the transmitter as you did when you initiated the original sync, and press the “i” pushbutton then the enter/return pushbutton to re-sync with the transmitter signal.

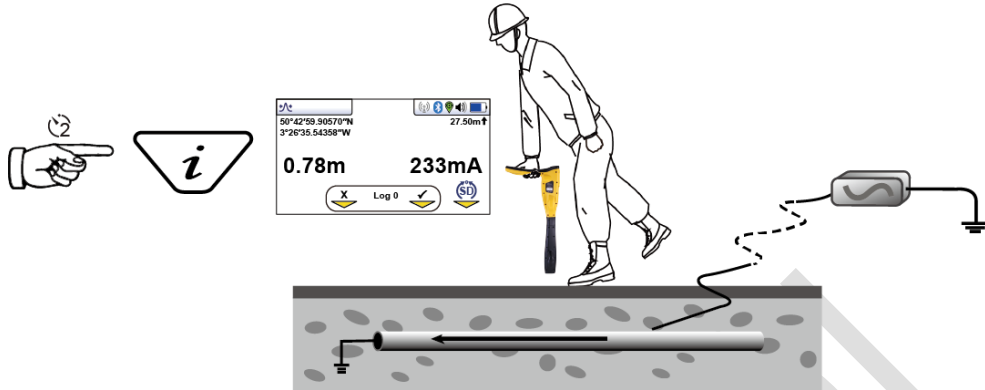

- Continue to locate, pinpoint and trace.

NOTE

If several lines are commonly bonded the signal direction will carry through to the other lines. This is useful for locating multiple line installations.

However, be aware that if a non-target line is commonly bonded to the target line, that line will also appear as being “in sync” with the target line.

When performing a reset, take care to ensure that you have not strayed from the target line.

5. Data Logging

The vLoc3-Pro has an internal memory that can be used to store locator data. Available storage size is four Gigabyte which relates to many thousands of records.

The records are user initiated. These are records stored by the user whenever the “+” button is pressed when in the “Information” screen.

Data can be stored relating to a standard locate or relating to any of the receiver accessories.

In addition to this, every time a self-test routine is run the results are also recorded in the equipment. This is not a user initiated record, it is done automatically after every self-test.

Warnings/Alarms are also automatically recorded.

To store a record first locate a point of interest. Hold the vLoc stationary over the target and press the “i” pushbutton. When in the depth and current screen, press the “+” pushbutton to save the data. The “Log” number indicates the number of records stored. To exit the screen without logging the data, press the “-” button.

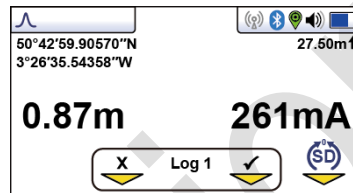

If the GPS function is enabled the GPS coordinates will also be displayed and attached to any saved file. For more information on Data logging and GPS see section 5.2.5.4.

When the save button is pressed the Log number will increment and the arrow below the check sign will turn green indicating that the data has been stored successfully.

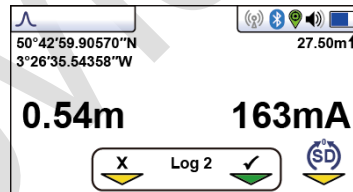

The screen will then automatically revert to the locate or accessory screen.

The data log can also be deleted from the Info screen. From the Info screen press and hold the “-” key. The message below will be shown.

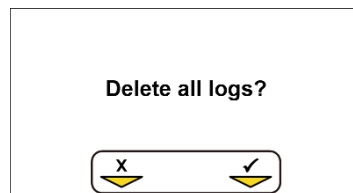

Press the “+” key to confirm. The locator will ask again “Are you sure?”. Press the “-” key to delete or the “+” key to cancel the deletion and return to the locate/accessory screen.

5 Data Logging

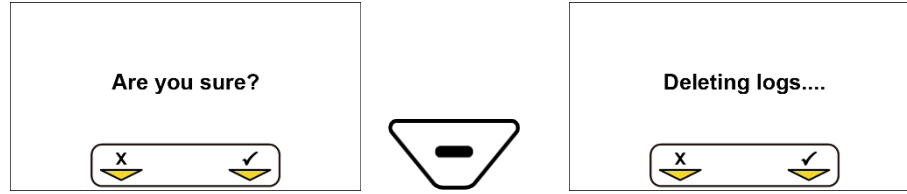

5.1 Bluetooth

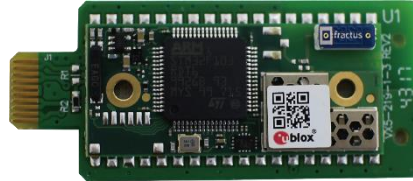

As an optional extra the vLoc3-Pro and vLocML3 receivers can be fitted with a Bluetooth communications accessory. This allows communication with external GPS and or Dataloggers. The Bluetooth option can be retrofitted and can be ordered at a later date if preferred.

5.1.1 Fitting the Bluetooth Module

1. Ensure the unit is switched off.
2. Use a small cross head screw driver to remove the two screws retaining the Bluetooth cover. This is found on the side of the locator next to the display unit. Remove the cover by lifting it way from the unit.



3. You will see that there are two slots. The BT module fits in the larger of the two slots. The smaller of the two is not active and allows for future developments. Take the Bluetooth module and carefully slide it into position. Replace the cover and tighten the two retaining screws being careful not to over tighten.
4. Switch on the unit and after a few seconds a black Bluetooth icon should appear showing that the module is fitted.
5. If the Blue tooth icon is grey, this means the GPS option is not fitted or incorrectly fitted.
6. The Bluetooth can communicate with external devices that are also Bluetooth enabled. Generally, Bluetooth devices fall into two categories, high or low power devices. The vLoc3-Pro Bluetooth is compatible with low power devices.

5.2 Pairing with external GPS/Dataloggers

To pair with an external device first ensure the Bluetooth option is fitted. This can be checked on the Status bar. If the Bluetooth icon is grey this means it is not fitted. Black icon indicates the option is fitted. The Bluetooth is retrofit table and is "Plug and Play".

Method

- Switch on the external device.
- Switch on the vLoc3-Pro and enter the User setup menu by a long press on the "I" button.
- Use the "+" and "-" keys to scroll down to the option "Bluetooth Pairing".
- Press the Enter key.
- Press the Enter key to commence "Bluetooth search".
- A list of available devices will be shown.
- Scroll down to the desired device and press the Enter key.
- Double press the "I" button to return to the main screen.
- After a few seconds the Bluetooth icon should turn blue indicating the device has paired successfully.
- The unit will remember the pairing even after switching off. However, the unit can only remember one unit at the time so if the unit is paired with another device the settings will be forgotten.

5 Data Logging

GPS (Global Positioning System)/GNSS (Global Navigation Satellite System)

The vLoc3-Pro can utilize location data from an external GPS/GNSS. For the vLoc3-Pro needs to be paired with an external device (See previous section on Bluetooth devices).

Once paired with an external device, the vLoc3-Pro will await valid GPS data from the external device. The GPS icon will turn green when a valid GPS signal is detected. This can take from a few seconds to a few minutes depending on the device and whether it is doing a "cold" or "hot" start.



5.3 Transferring Data from the Locator to a Computer

To transfer data it is necessary to use the vLoc3-Pro Configurator Tool called Mylocator3. This is a simple program that can be downloaded from the Vivax-Metrotech web site at www.vivax-meterotech.com.



TIP

To view Google files it is first necessary to install the Google earth application to your computer. This is a free application which can be found at <http://www.google.com>

5.3.1 MyLocator3

This section describes the user operation of the MyLocator3 PC application.

MyLocator3 is a desktop PC application which is capable of downloading code and configuring the vLoc3-Pro series of locators.

The first part of this document (Basic Operation) describes usage not requiring a USB security dongle. The second part of this document (Advanced Features) describes usage requiring a security dongle.

MyLocator3 is available to download free from www.vivax-meterotech.com.

Follow the instructions to download and install the application.



A "MyLocator3" icon will appear on the computer desktop. MyLocator3.

Connect your vLoc3-Pro to your computer via the mini USB connector which can be found under the battery cover flap.

Launch MyLocator3 by double clicking on the icon.

5.3.2 My Locator3's Basic Operation

MyLocator3 operation, not requiring a USB security dongle.

5.3.2.1 Updates Page

When a locator is first connected to the PC, the “**Updates Page**” will be displayed and this will show the locator variant type along with the locator serial number and the running firmware version in the upper left-hand box. The upper right-hand box will show information about the MyLocator3 PC application.

Clicking on the Clock symbol sets the locator time to UTC time. To check local and UTC time, hover over the icon and the times will be displayed to the right, flashing alternately.

MyLocator3 can also be viewed in a number of language options. Click on the pull-down menu to select the desired option.

Checking the “Auto Load Config” box ensures the configuration settings of the locator are automatically uploaded to the MyLocator3 app when the locator is connected.

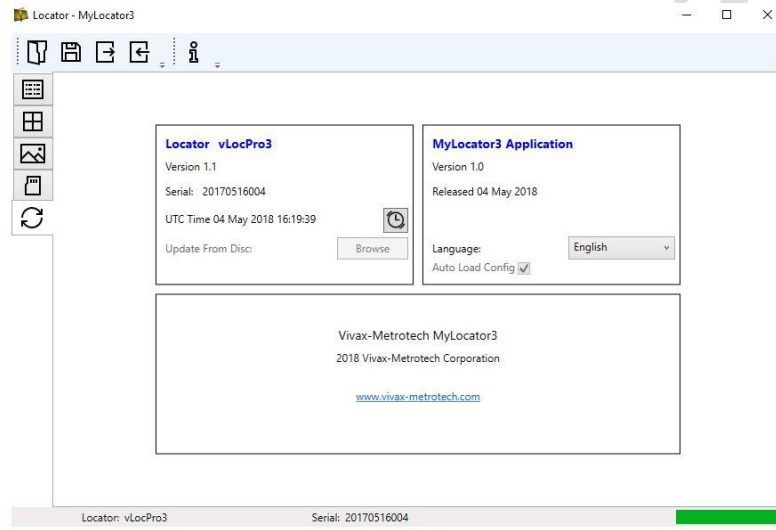

5 Data Logging

5.3.2.2 Application Update

Every time the MyLocator3 Application is started its version number is checked against the latest version available on the Vivax-Metrotech server and the user is notified if an update is available as shown below. This feature will only be available if the computer is “online”.

Clicking on the Update Now button will download the latest version from the Vivax-Metrotech server which can then be installed by the user.

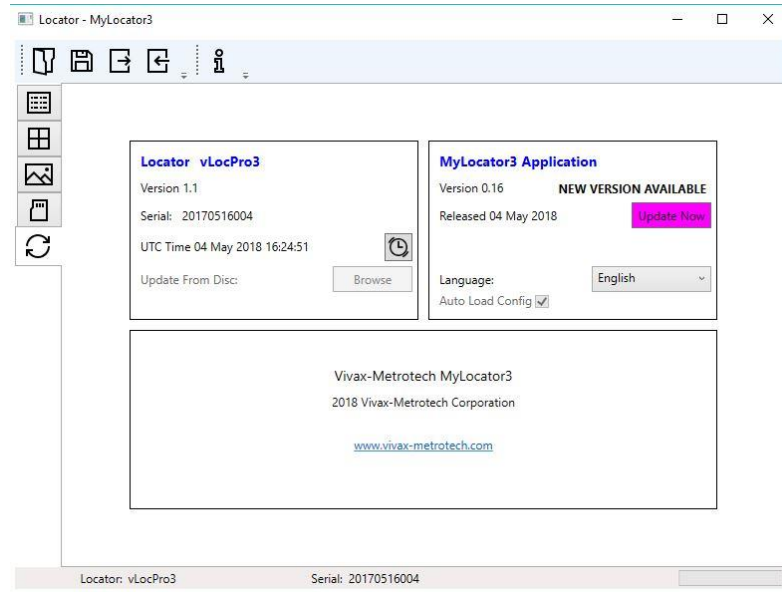

5.3.2.3 Locator Firmware update

Each time a locator is connected to the PC, its firmware version is checked against the latest version available on the Vivax-Metrotech server and the user is notified if an update is available as shown below. This feature will only be available if the computer is “online”.

Clicking on the Update Now button will fetch the latest version from the server and then download it to the locator.

The “Update From Disc” feature will only be available if a suitable dongle is also attached to the PC. This feature allows the user to install older versions of firmware stored on the computer, although it is advised that only the latest version of firmware is used.

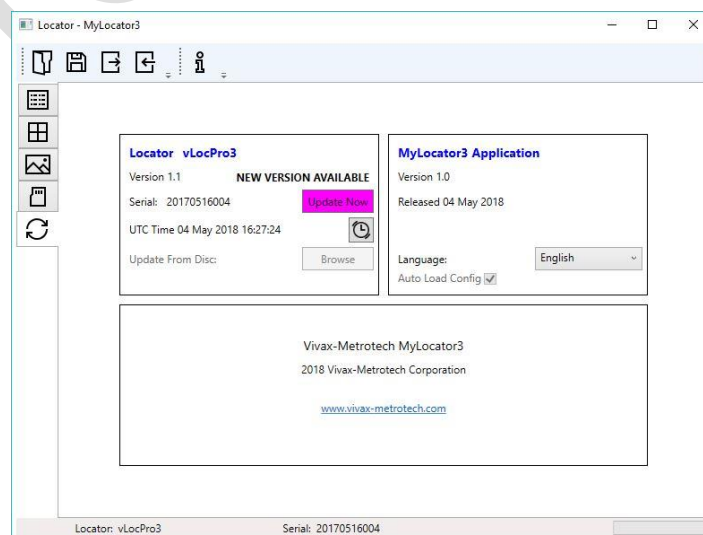





5.3.3 Toolbar

The vLoc3-Pro locator can be configured so that features can be switched on or off. This enables the user to tailor the instrument to meet the needs of their application while keeping the user interface uncluttered. The toolbar at the top of the screen enables the user to create configurations.

The application toolbar looks like this:



	This will open an existing configuration file (*.vmcfg).
	This will save the configuration to a file.
	This will write the configuration to the connected locator.
	This will read the configuration from the connected locator.
	This will display information about MyLocator3.

5.3.4 Data Logging

Clicking on the Data Logging tab will display information about the state of the attached locator's data log contents. The data log contents can be stepped-through by using the controls on the right-hand side. The user can upload a selection of logs from the locator to the PC by using the controls in the upper right-hand side. The data in the data log can be configured before exporting. The parameters that can be set are:

- Distance units
- Date format
- Time format i.e. UTC or local time

Files may be exported/saved locally as .csv/.bin/.kml/.shp files and examined later. The default filename is based on the serial number of the connected locator but can be changed during the saving process.



Tip

If it is only required to export a portion of the log (for instance, a survey on a particular day) use the data log scroll facility at the bottom left of the display, to scroll through to the start date/time. Note the log number and then scroll to the end date/time and note also this log number. Use these numbers to enter the "From" "To" numbers in the top right of the display when exporting. This will help to keep the exported data to a manageable size.

5 Data Logging

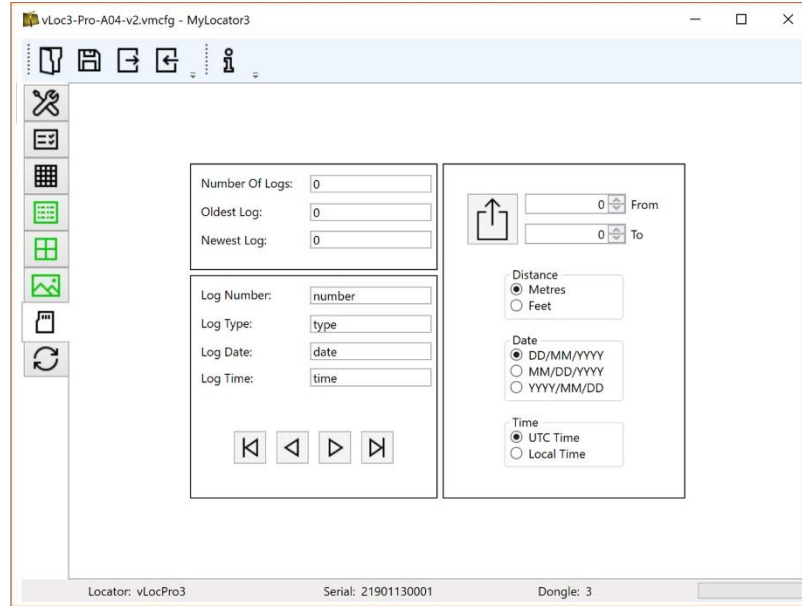

5.3.5 Splash Screen

On this page an image can be loaded which can be used as a splash screen by the locator when it is switched on. The locator has an LCD screen with a resolution of 480 by 272 pixels. The image loaded into MyLocator3 will be scaled to fit the width of the screen. If the scaled image height is less than the LCD height, then the image is centered vertically and white bars are used as padding. If the scaled image height is greater than the LCD height, then the image can be re-positioned vertically by clicking and dragging the left mouse button anywhere on the image.

To insert your own start up screen first click on the "Open" button. Then browse your files to select the picture required as the startup screen. The application is compatible with file formats .jpg/.bmp/.png, and .gif.

The startup screen will be displayed in the application.

The Download button can be used to set the splash screen immediately or the image can be sent to the locator along with the rest of the configuration by pressing the Write Configuration button.

To remove a startup screen and revert to the default Vivax-Metrotech screen click on the "Clear" button and download the cleared screen.

5 Data Logging



5.3.6 Frequencies Page

The "Frequencies" page will allow the user to refine which frequency modes are available when the locator F-key is pressed and which frequencies appear on the locator menu.

The screenshot shows a software window titled "VLP3TEST.vmcfg - MyLocator3". The main area displays a table with three columns: "Frequency", "On Menu", and "On f-key". The table lists various frequency modes and their settings. The "On Menu" and "On f-key" columns contain checkboxes. The "On f-key" column also contains a right-pointing arrow icon for expandable items.

Frequency	On Menu	On f-key
Power 50	<input checked="" type="checkbox"/>	<input checked="" type="checkbox"/>
Power 60	<input checked="" type="checkbox"/>	<input checked="" type="checkbox"/>
Radio	<input checked="" type="checkbox"/>	<input checked="" type="checkbox"/>
50Hz	<input checked="" type="checkbox"/>	<input type="checkbox"/>
60Hz	<input checked="" type="checkbox"/>	<input type="checkbox"/>
98Hz	<input checked="" type="checkbox"/>	<input type="checkbox"/>
CP100	<input checked="" type="checkbox"/>	<input type="checkbox"/>
CP120	<input checked="" type="checkbox"/>	<input type="checkbox"/>
128Hz	<input checked="" type="checkbox"/>	<input type="checkbox"/>
SD-USA	<input checked="" type="checkbox"/>	<input checked="" type="checkbox"/>
273Hz	<input checked="" type="checkbox"/>	<input type="checkbox"/>
SD-EUR	<input checked="" type="checkbox"/>	<input checked="" type="checkbox"/>
480Hz	<input checked="" type="checkbox"/>	<input type="checkbox"/>
SIS491Hz	<input checked="" type="checkbox"/>	<input checked="" type="checkbox"/>
512Hz	<input checked="" type="checkbox"/>	<input checked="" type="checkbox"/>
577Hz	<input checked="" type="checkbox"/>	<input type="checkbox"/>
815Hz	<input checked="" type="checkbox"/>	<input type="checkbox"/>
950Hz	<input checked="" type="checkbox"/>	<input type="checkbox"/>
SIS982Hz	<input checked="" type="checkbox"/>	<input checked="" type="checkbox"/>
1.02kHz	<input checked="" type="checkbox"/>	<input type="checkbox"/>
1.03kHz	<input checked="" type="checkbox"/>	<input type="checkbox"/>
1.09kHz	<input checked="" type="checkbox"/>	<input type="checkbox"/>
1.17kHz	<input checked="" type="checkbox"/>	<input type="checkbox"/>
1.45kHz	<input checked="" type="checkbox"/>	<input type="checkbox"/>

At the bottom of the window, it shows "Locator: vLocPro3" and "Serial: 20171027008".

5.3.7 Menu Settings

The "Menu Settings" page allows the user control over which menu items appear on the locator and also the initial setting of the menu item when the locator is first used after configuration.

The menu items with a right pointing arrow  can be expanded to reveal further sub-menu items. If the "On-Menu" item is ticked, then the item will appear on the locator menu. The item displayed in the "Setting" column will be the initial locator setting after configuration. If the "Setting" value is not selected, then the locator setting will be unchanged.

5 Data Logging

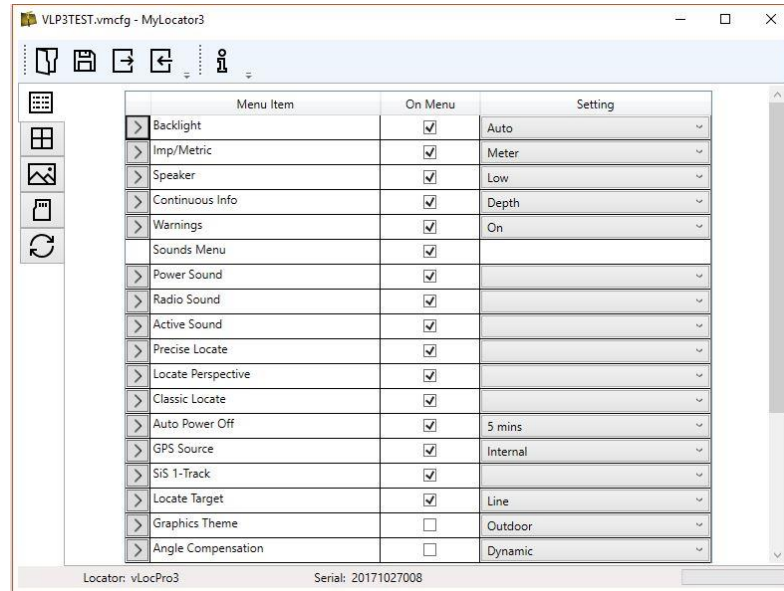

5.3.8 Advanced Features

The Advanced Features are available to those users in possession of a USB security dongle. If a dongle is attached to the PC then its level will be displayed on the MyLocator3 status bar.

5.3.8.1 Supervisor Lockouts

This feature is available to anyone with a dongle (Contact Vivax-Metrotech for the purchase of a dongle). When a dongle is connected to your computer via a standard USB socket, the icons for the “Splash Screen” page, “Frequencies” page and “Menu Settings” page will change color to green. This color indicates the page is unlocked.

The Splash Screen page, Frequencies page and Menu Settings page can each be individually locked by double-clicking on their page tab icon. If a page is locked then it can only be accessed by a user with an appropriate security dongle. This will prevent unauthorized users from changing protected locator items. i.e. the “Splash Screen” can be locked to prevent the user from changing it.

The page tab icon will change color from green to amber.

To unlock a tab, with the dongle connected, double click on the tab to unlock.

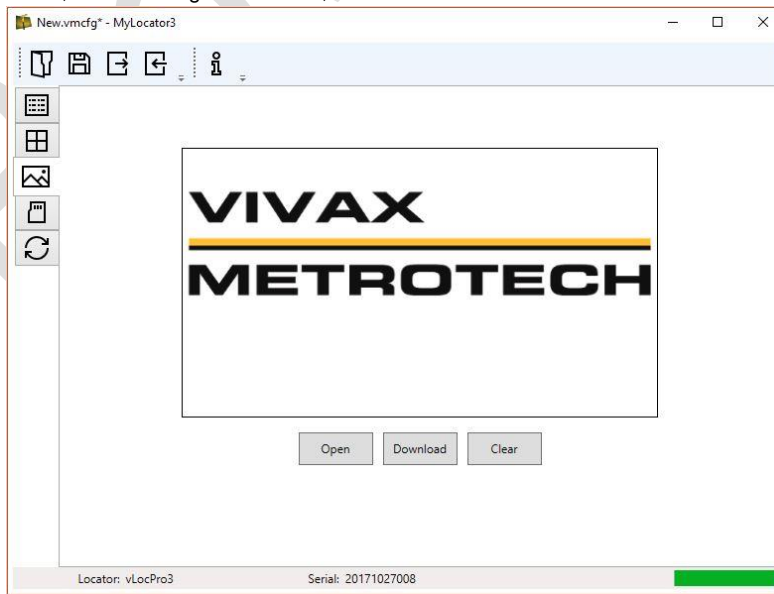

6. Loc-10Tx Transmitter

6.1 Loc-10Tx Transmitter Overview

The Loc-10Tx transmitter is a rugged portable transmitter powered by alkaline “D” cells or Ni-MH (Nickel Metal Hydride) rechargeable batteries. The following describes the features and uses of the transmitter.

6.1.1 Display

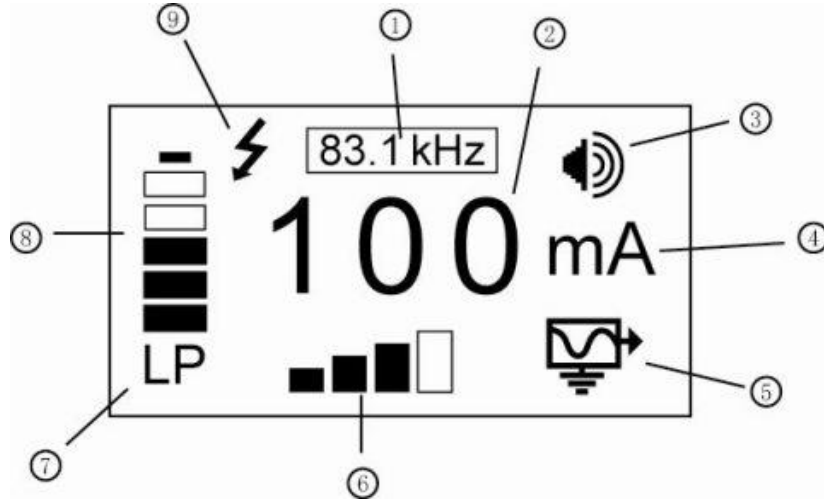

1	Frequency Being Transmitted	6	Output Setting (Step) (filled box indicates current level has been reached, empty box indicates requested current level has not been achieved)
2	Digital Read Out (mA, volts, ohms)	7	Low Power Indicator (enabled automatically when battery becomes one bar)
3	Loudspeaker Level	8	Battery Status
4	Units (mA, volts, ohms)	9	High Voltage Warning* (output is enabled for high voltage)
5	Mode Indication Icon		

External Voltage Warning

The transmitter checks the line when connected. If the line is carrying voltages in excess of 25V, it will display the “high voltage” warning icon, and not allow the transmitter to operate. In addition, the transmitter is protected by a 1.5A/250V fuse in the event of excessive voltage or voltage spikes on the line.

6.1.2 Pushbuttons

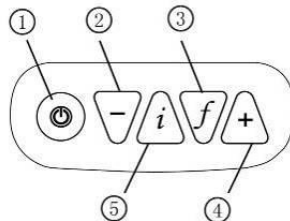

1	On/Off Control
2	Output Decrease/Navigate through menu
3	Frequency Select
4	Output Increase/Navigate through menu
5	Information (Volume, Volts, Ohms, LCD Contrast, Multi Frequencies, Frequency Menu)

6.1.3 Information Pushbutton

6 Loc-10Tx Transmitter

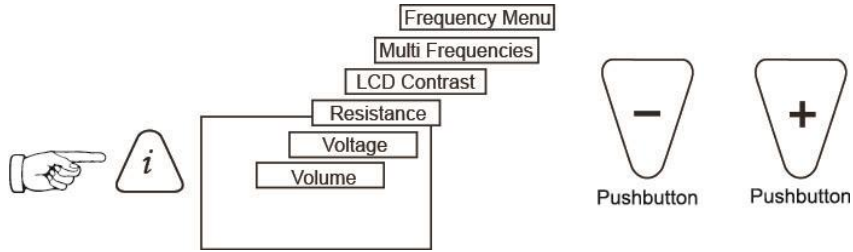

When the “i” (information) pushbutton is pressed, the display will show the volume level of the audio; use the “+” and “-” pushbuttons to increase/reduce the volume or turn the beeper off (off – low – medium – high).

By pressing the “i” (information) pushbutton the display can be toggled to show “voltage” and “resistance”. The display indicates mA, as the default, and volts or ohms when selected.

6.1.4 Connections Block

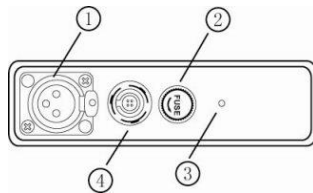

1	Output Connection
2	Output Protection (Fuse)
3	Loudspeaker
4	Battery Charging Socket & DC Input

All the connections made to the transmitter are made at the connection block except for a USB socket which is mounted inside the battery compartment and is used for transmitter’s software upgrade.

The connection block consists of:

- Output (XLR) socket – for the direct connection lead and clamp.
- Charger socket (to charge rechargeable battery pack – the charging socket is present even if rechargeable batteries have not been purchased).
- Transmitter 12V DC power lead used to power the transmitter from a vehicle (**not** for charging).
- Fuse – this protects the transmitter circuitry in the event of the transmitter receiving up to 250V incoming voltage on the output leads, or higher than allowed current.
- A beeper is positioned behind the small hole.

6.2 Transmitter Battery



In most markets the transmitter is shipped with alkaline batteries (12 x D cells) unless rechargeable batteries are specified. Batteries are fitted into quick release trays – the alkaline is an open pack, to enable the batteries to be changed. The rechargeable pack is a sealed unit containing Ni-MH (Nickel Metal Hydride) batteries. These packs can only be fitted in a manner to ensure that the alkaline batteries cannot be inadvertently charged.

The battery condition (charge) is displayed on the left side of the display. “LP” letters appears when the battery charge becomes one bar.

6.2.1 Removing the Battery Tray

6 Loc-10Tx Transmitter

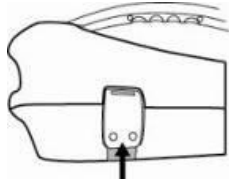

Push up button

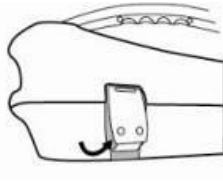

Pull out bottom of catch

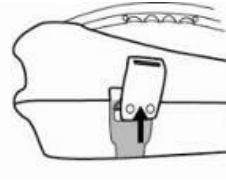

Lift up catch until it clears catch plate

6.2.2 Replacing the Alkaline Battery

- To access batteries – undo stainless steel screws on each battery cover
- To remove batteries – turn tray upside down and give a short sharp tap of the battery tray on your hand
- Replace batteries with new batteries of the same type, be sure not to mix old and new batteries
- **Do not** use rechargeable batteries in the alkaline battery tray. Ensure that batteries are inserted the correct way (see label and molded “+” and “-” in the bottom of the tray)
- Refit the battery cover – then refit the battery tray

WARNING

Alkaline Batteries – insert alkaline batteries (x12) as shown:

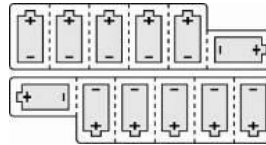

6.2.3 Rechargeable Batteries

- **Do not** attempt to replace the rechargeable batteries or remove battery covers – return to Vivax-Metrotech or a Vivax-Metrotech approved service centers for replacement.



WARNING

Use only Vivax-Metrotech recommended charger.

6.2.4 Re-fitting the Battery Tray

To close battery tray – slid transmitter (TX) onto tray, it will locate itself in the correct position, then close the catches.

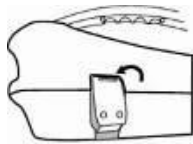

Place top of catch over catch plate

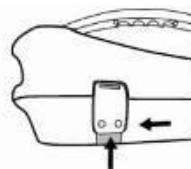

Push up button underneath the catch – where holding that up push in the bottom of the catch. You will hear a positive “click” (**Do not** force catches)



WARNING

Power “IN” socket

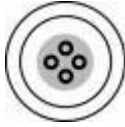

Two pins are used for power in from charger (to charge rechargeable batteries). Two pins are used for power from external 12V DC source. A 12V DC power cable is supplied and is designed to be connected to an automobile cigarette lighter socket.

6.2.5 Rechargeable Battery Pack Charging and Disposal

Follow instructions detailed in the General Safety & Care portion of this document.

Only use the battery charger supplied. Using a non-approved charger may damage the battery pack and could cause overheating.

To charge, the rechargeable batteries pack must be connected to the transmitter. Connect the mains charger to the charging socket on the side of the transmitter and connect the charger to a suitable mains socket.

The LED on the charger will show a red light indicating that the charge cycle is in progress. When the batteries are fully charged the LED will change to green.



NOTE

Rechargeable pack cannot be charged from a 12V DC source.

6.3 Transmitting Modes

The transmitter has three transmitting modes, which are selected automatically.

6.3.1 Induction Mode

This uses an internal antenna to induce a locating frequency onto the target pipe or cable (line). "Induction" mode is automatically selected if no connection accessories are plugged into the "output socket". An icon indicating "Induction" mode shows on the display. The icon flashes when the transmitter is transmitting. In order to generate successful induction, the transmitter should be positioned over and with the handle in line with the target line.

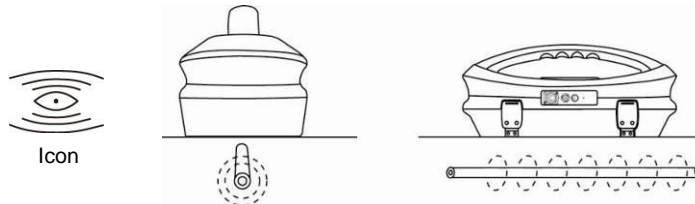

"Induction" mode is generally used when no access is available to make a direct connection, or a clamp connection. When using induction, it is very likely that the signal being induced onto the target line will also be induced onto other lines in the area, and onto above ground features such as wire fences. This can influence the accuracy of the location, depth and current measurements. "Induction" mode is also the least efficient way of applying the transmitting signal to the target line. The distance located with "Induction" mode is generally much less than that achieved with a direct connection or clamp connection.

"Induction" mode generally works better in higher frequencies. The advantage of induction is that no access is required to "connect" the transmitter, making it a very quick process. The antennas on the transmitter are tuned to induce specific frequencies or range of frequencies. Therefore, only a limited number of frequencies can be selected in "Induction" mode.

All the frequencies in favorite frequencies mode that are higher than 8 kHz can be selected by pressing "f" pushbutton in main display. Multiple induction frequencies are available based on the user selection. See section 6.4.2 for adding and removing frequency from the favorite frequencies list.



NOTE

For accurate location and depth measurement the locator receiver should be used no closer than 50ft (15m) from the transmitter.

6.3.2 Direct Connection Mode

By plugging in a connection lead to the output socket, "Direct connection" mode is selected. An icon confirming this is shown on the display. The wave in the icon fluctuates when the transmitter is transmitting. The direct connection lead consists of two cables, one (red clip) must be connected to the conductor being located, the other (black clip) to a suitable ground (a ground stake is provided with the transmitter). An auxiliary ground lead is also supplied. If the auxiliary ground lead is used, the ground clip of the connection lead (black clip) is attached to one end of the auxiliary ground lead.

A good connection is indicated by a change in beep rate from the speaker and the current reading on the display.

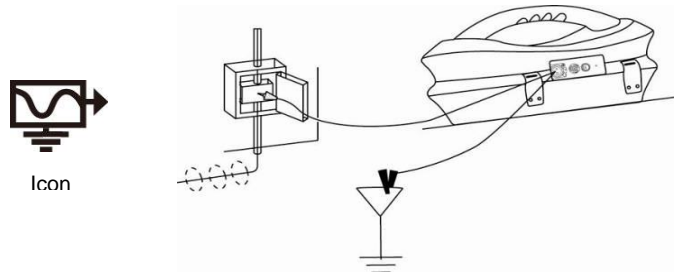

Wherever a direct connection can be safely made without the risk of injury, damage to customer's plant, or the transmitter, it is the best way of applying the transmitter's signal.

The coupling of the transmitted signal to other pipes and cables in the area will be much less than with induction, although where commonly bonded systems are encountered – coupling cannot be avoided.

The positioning of the ground connection can also influence the degree of coupling experienced. Ground connections generally should not be made to other pipes or cables, or above ground metallic structures such as wire fences. In general, the lower the frequency is, the further the signal will travel, and the less signal coupling will occur. The most common frequencies used for direct connection are between 512 Hz/640 Hz and 8 kHz.

Regulations in many countries require that power output is limited above certain frequencies. The Loc-10Tx enables frequencies below 45 kHz to be transmitted using as much as 10 watts output, but frequencies over 45 kHz are restricted to 1 watt. Using direct connection and the higher power at the low frequencies helps significantly in achieving greater location distances. Direct connections should not be made to cables carrying greater than 25V (or as your safety practices allow). The transmitter is protected (250V fuse) from stray currents that may exist on the target line.

6.3.3 Clamp Mode

Plugging the signal clamp supplied by Vivax-Metrotech into the output socket will place the transmitter in "Clamp" mode. An icon confirming this is displayed on the display. The icon flashes when the transmitter is transmitting. When using the clamp, no ground connection is needed.

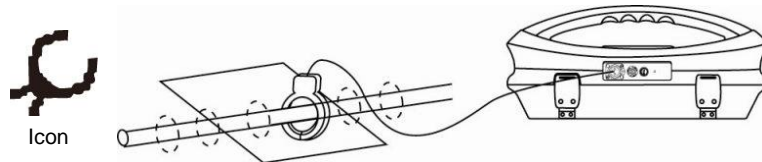

The clamp again is a precise way to apply the locating signal. It is generally used when access to the conductor cannot be achieved to make a direct connection (but there is sufficient access to place the clamp around the cable), or when it is not safe to make a direct connection because the target cable is carrying electricity.

The clamp is a specialized inductive device (sometimes known as a toroid or coupler). All clamps are optimized to work at specific frequencies. In most cases clamps are designed to be used at frequencies generally between 8 kHz and 83 kHz. The transmitter will only allow the selection of a suitable range of frequencies for your clamp.



WARNING

When applying the clamp to cables that carry electricity – be sure to follow your company's safety instructions and procedures. Beware that if applied around a high voltage cable – that cable may induce a current in the clamp causing it to snap shut or jump quite dramatically – always apply clamps carefully.

6.4 Frequencies

6.4.1 Frequencies and Power Output

The Loc-10Tx transmitter is supplied with a predefined set of transmit frequencies. The most commonly used frequencies will be preset by the factory. Additional frequencies are available to be select in the frequencies list see section 6.4.2.

Example of standard frequencies/preset at the factory are:

- 512Hz (where electrical systems are 60Hz) direct connection – 10 watts.
 - 640Hz (where electrical systems are 50Hz) direct connection – 10 watts.
 - 8 kHz direct connection – 10 watt.
 - 33 kHz direct connection – 10 watt.
 - 65 kHz direct connection – 1 watt.
 - 83.1 kHz, 131 kHz direct connection – 1 watt (depending on region).
 - 200 kHz direct connection – 1 watt (depending on region).
 - Some other frequencies with 10 Watt output:
 - Direction connection: 256Hz, 491Hz, 982Hz, etc.
 - Direct and clamp connection : 8.19 kHz, 8.44 kHz, 9.5 kHz, 9.82 kHz, 32.8 kHz, 38 kHz .
 - Some other frequencies with 1W output: 89 kHz, 131 kHz, 200 kHz.
 - Clamp connection: any frequency from 8 kHz up to the highest allowed frequency (depending on region).
 - Induction Frequency: this transmitter is a broad-band induction unit. It means that user can select for the Induction mode any frequency he wants, from 8 kHz up. (highest available frequency depends on region)
- NOTE: see section 6.4.2 for frequency activation procedure.

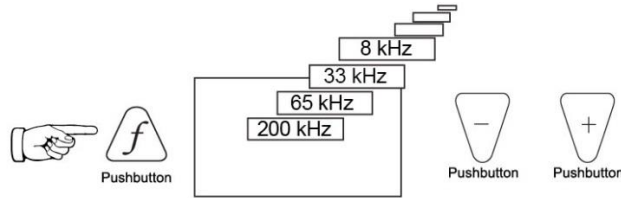

As with most manufacturers the clamps and induction antennas are tuned to specific frequencies, and **do not** work over the complete range of frequencies.

Frequencies are selected by pressing the “f” pushbutton which toggles through the available frequencies for the selection mode. The frequency is automatically selected if you don't toggle past it within two seconds. The frequency is shown on the display.

NOTE:

The output current is shown in large characters on the display – to increase or reduce the power output press “+” or “-”. The vertical bar graph at the bottom of the display indicates which of the four current output steps is being used. If the transmitter can supply the requested current, the bar will turn black. If the bar does not turn black, improving the ground connections or wetting the ground where the earth stake in positioned, may help. However, it may not be able to achieve the current setting requested because the impedance of the line is too high for this setting. If this happens it is best to select a setting that has a black bar, this will ensure a stable output.

The current being transmitted will be limited by the impedance of the cable, therefore it is not unusual to increase the output level, but see no increase in the current displayed. This is not a fault with the transmitter.

The transmitter will always revert to first level output when switched on – this is a power saving feature – in most circumstances this output level is sufficient. Increasing the output power unnecessarily will reduce the battery life unnecessarily. All other settings remain the same as the last setting used.

6.4.2 Most Used Frequencies (Frequency Selection) Feature

This feature can be used to allow operator to choose his most used frequencies from a list of possible frequencies. Once these frequencies are selected in the main menu, pressing the "f" pushbutton, user can scroll through them. At any time, user can add or remove frequencies from the above list, following the below procedure. Maximum frequencies that can be appear in most used frequencies list is 12.

The advantage of this feature is that user can optimize the transmitter and activate at the main menu user's preferred frequencies, instead of having a whole list of frequencies that user has to scroll through.

To enter the "Frequency Menu" proceeds as follows:

1. Press the "i" pushbutton four--six times (based on the mode that transmitter is in), until get to the "Frequency menu" sub-menu.

In Direct Connection mode,

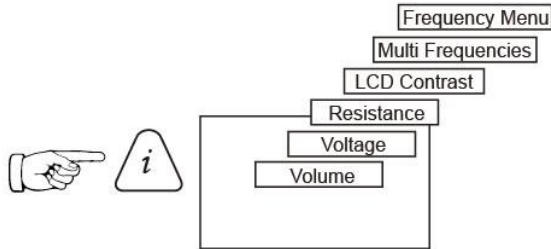

In SD mode,

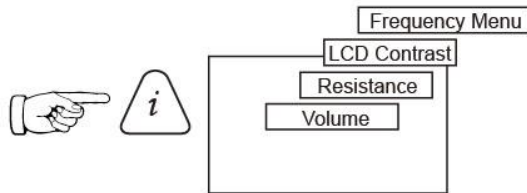

In Clamp mode,

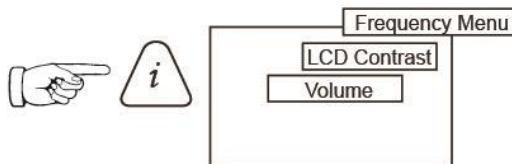

2. Screen will show a list of frequencies available, with the central one in a box.

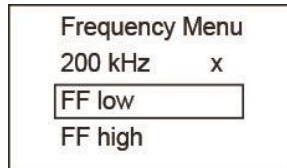

3. Pressing the "+" or "-" pushbuttons, you can scroll up or down through the available frequencies.
4. Once the wanted frequency is inside the box, press "f" pushbutton to select or deselect the frequency. An "x" will appear in the box for a selected frequency.

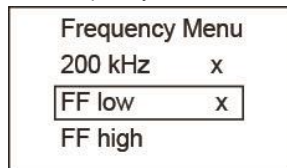

5. After selecting the frequencies, press the "i" pushbutton again to exit the "Frequency Menu" and return to the main display.

6 Loc-10Tx Transmitter

- A particular frequency in the chosen list of frequencies can be selected from the main display screen by pressing the "f" pushbutton until the wanted frequency is displayed at the top of the main screen.

6.4.3 Multi Frequency Mode for Direct Connection

This feature can be used when user wants to energize on target two/three frequencies at the same time. Mainly, it can be used when user is not sure which frequency can be impressed better into the target. Multi frequency mode is not available in Fault Find and SD modes.



NOTE

- When using multi frequency mode, total power will be split between the activated frequencies.
- The frequencies have to be available in the main menu.

To enter the "Multi Freq. Setup" menu, proceeds as follows:

- Press "i" pushbutton five times to get to the "Multi Frequency" screen and press "f" pushbutton to activate the multi frequency mode. An "x" symbol will appear indicate the multi frequency mode is activated. Press "f" pushbutton again to go in "Multi Freq. Setup" screen to choose the frequencies.

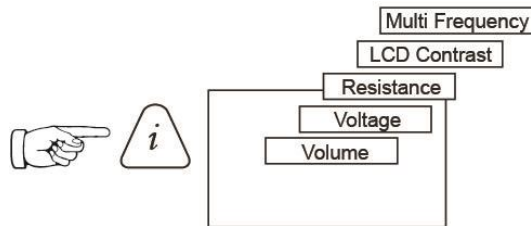

- Use the "+" and "-" pushbuttons to scroll through the available frequencies, and bring the wanted one in the first box.

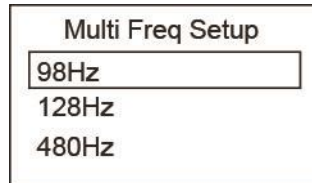

- Press "f" pushbutton to move the box down and the "+" and "-" pushbuttons to select the second frequency.

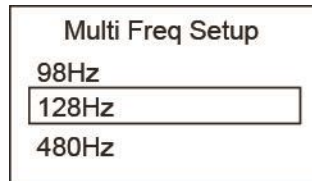

- Repeat step three to select the third frequency if needed.
- Press "i" pushbutton to return to main display. On the main display, "Multi" will appear indicating the multi frequency mode is active.

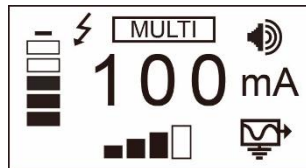

- The frequencies selected for multi frequency mode will be saved until changes are made even when the multi frequency mode is deactivated.

7. Loc-5STx Transmitter

7.1 Loc-5STx Transmitter Overview

The Loc-5STx transmitter is a rugged portable transmitter powered by alkaline “D” cells or Li-ion rechargeable batteries. The following describes the features and uses of the transmitter.

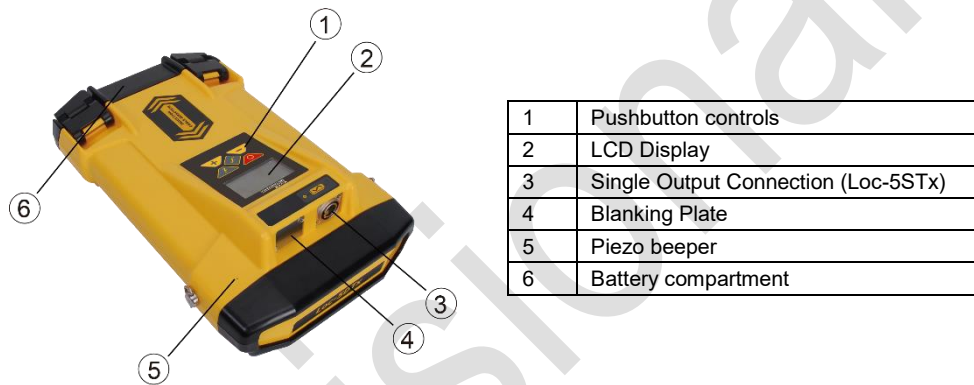

- A USB socket is mounted inside the battery compartment and is used for transmitter’s firmware upgrade.
- The beeper is positioned behind a small hole on one side of the housing.

7.1.1 Display

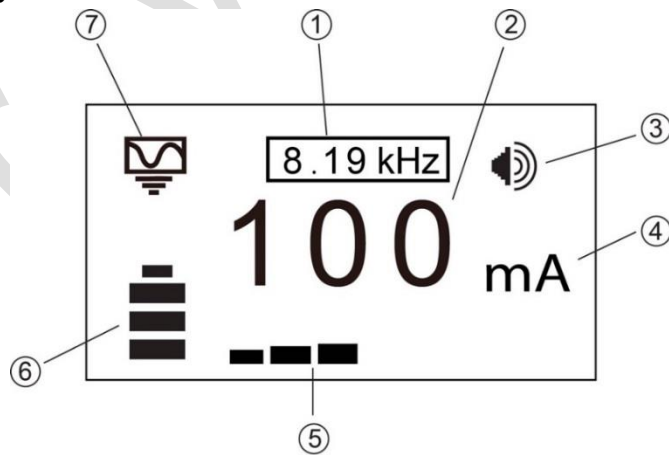

1	Active Frequency	5	Output Setting (Step) (filled box indicates current level has been reached, empty box indicates requested current level has not been achieved)
2	Digital Readout (mA, volts, ohms)	6	Battery Status
3	Beeper Level	7	Mode Indication Icon
4	Units (mA, volts, ohms)		

***External Voltage Warning**

The transmitter checks the line when connected. If the line is carrying voltages in excess of 25V, it will display the “high voltage” warning icon, and not allow the transmitter to operate. In addition, the transmitter is protected in the event of excessive voltage or voltage spikes on the line.

7.1.2 Pushbuttons

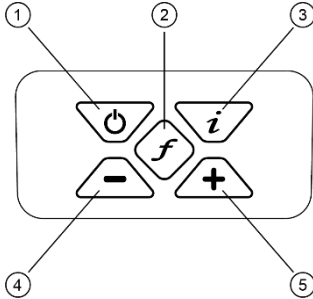

1	On/Off
2	Frequency Select
3	Information (Volume, Volts, Ohms, LCD Contrast, Multi Frequencies, Frequency Menu)
4	Output Decrease/Navigate through menu
5	Output Increase/Navigate through menu

7.1.3 Information Pushbutton

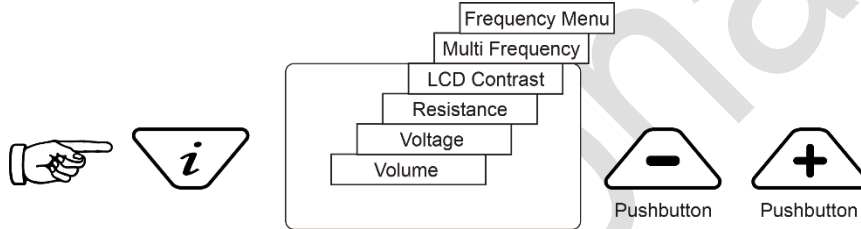

When the “i” (information) pushbutton is pressed, the display will show the audio volume level , use the “+” and “-” pushbuttons to increase/reduce the volume or turn the beeper off (off – low – medium – high).

By pressing the “i” (information) pushbutton the display can be toggled to show “voltage” and “resistance”. The display indicates mA, as the default, and volts or ohms when selected.

7.2 Transmitter Battery



By default, transmitters are shipped with eight D cell alkaline batteries. A rechargeable Li-ion (Lithium-ion) battery kit is available as an accessory. The battery status is displayed on the left side of the display.

The letters “LP” will appear when the battery status reaches only one bar. At this battery level the max output current and power is limited.

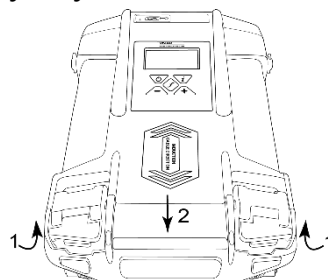

7.2.1 Removing the Battery Tray



7.2.2 Replacing the Alkaline Battery

- To access batteries – undo the two latches that are locking the battery cover.
- To remove batteries – remove the battery holder from the inside of the unit.

7 Loc-5STx Transmitter

- Replace batteries with new batteries of the same type, be sure not to mix old and new batteries.
- Do not use rechargeable batteries in the alkaline battery tray. Ensure that batteries are inserted the correct way (see label and molded “” and “” in the bottom of the tray).
Refit the battery tray – then close the battery cover.

WARNING

Alkaline Batteries – insert alkaline batteries (x 8) as shown:



7.2.3 Rechargeable Batteries

- **Do not** attempt to replace the rechargeable batteries or remove battery covers – return to Vivax-Metrotech or a Vivax-Metrotech approved service center for replacement.



WARNING

Use only Vivax-Metrotech recommended charger.

7.2.4 Re-fitting the Battery Tray

To close the battery compartment – place the two catches into their position, then close the catches.

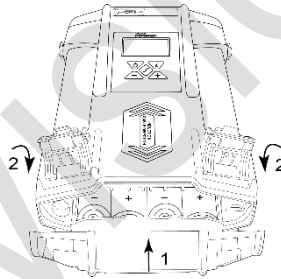

7.2.5 Rechargeable Battery Pack Charging and Disposal

Follow the instructions in the General Safety & Care section portion of this document.

Only use the battery charger supplied with the battery. Using a unapproved charger may damage the battery pack and could cause overheating.

The rechargeable battery pack must be connected to the transmitter in order to charge. Connect the charger to the charging socket on the inside of the transmitter and connect the charger to a suitable mains socket.

The LED on the charger will show a red light indicating that the charge cycle is in progress. When the batteries are fully charged the LED will change to green.



NOTE

Rechargeable pack cannot be charged from a 12V DC source.

7.3 Transmitting Modes

The transmitter has three transmitting modes, which are selected automatically.

7.3.1 Induction Mode

This uses an internal antenna to induce a locating frequency onto the target pipe or cable (line). “Induction” mode is automatically selected if no connection accessories are plugged into the “output socket”. An icon

7 Loc-5STx Transmitter

indicating "Induction" mode shows on the display. The icon flashes when the transmitter is transmitting. In order to generate successful induction, the transmitter should be positioned over and with the handle perpendicular to the target line.

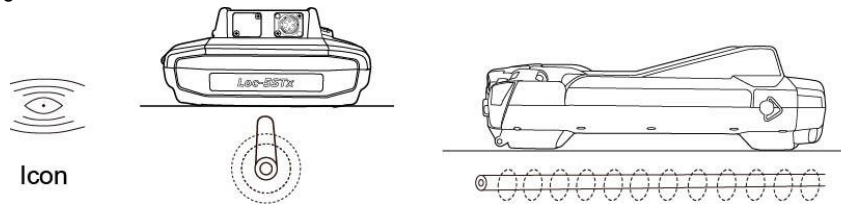

"Induction" mode is generally used when no access is available to make a direct connection, or a clamp connection. When using induction it is very likely that the signal being induced onto the target line will also be induced onto other lines in the area, and onto above ground features such as wire fences. This can influence the accuracy of the location, depth and current measurements. "Induction" mode is also the least efficient way of applying the transmitting signal to the target line. The distance located with "Induction" mode is generally much less than that achieved with a direct connection or clamp connection.

"Induction" mode generally works better in higher frequencies. The advantage of induction is that no access is required to "connect" the transmitter, making it a very quick process. The antennas on the transmitter are tuned to induce specific frequencies or range of frequencies. Therefore only a limited number of frequencies can be selected in "Induction" mode.

All the frequencies in favorite frequencies mode that are higher than 8 kHz can be selected by pressing "f" pushbutton in main display. Multiple induction frequencies are available based on the user selection. See section 7.4.2 for adding and removing frequency from the favorite frequencies list.



NOTE

For accurate location and depth measurement the locator receiver should be used no closer than 50ft (15m) from the transmitter.

7.3.2 Direct Connection Mode

By plugging in a connection lead to the output socket, "Direct connection" mode is selected. An icon confirming this is shown on the display. The wave in the icon fluctuates when the transmitter is transmitting. The direct connection lead consists of two cables, one (red clip) must be connected to the conductor being located, the other (black clip) to a suitable ground (a ground stake is provided with the transmitter). An auxiliary ground lead is also supplied. If the auxiliary ground lead is used, the ground clip of the connection lead (black clip) is attached to one end of the auxiliary ground lead.

A good connection is indicated by a change in beep rate from the speaker and the current reading on the display.

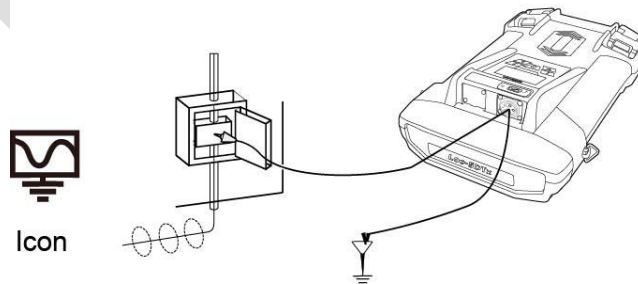

Wherever a direct connection can be safely made without the risk of injury, damage to customer's plant, or the transmitter, it is the best way of applying the transmitter's signal.

The coupling of the transmitted signal to other pipes and cables in the area will be much less than with induction, although where commonly bonded systems are encountered – coupling cannot be avoided.

The positioning of the ground connection can also influence the degree of coupling experienced. Ground connections generally should not be made to other pipes or cables, or above ground metallic structures such as wire fences. In general the lower the frequency is, the further the signal will travel, and the less signal coupling will occur. The most common frequencies used for direct connection are between 512 Hz/640 Hz and

7 Loc-5STx Transmitter

8 kHz.

Regulations in many countries require that power output is limited above certain frequencies. The Loc-5STx enables frequencies below 45 kHz to be transmitted using as much as 5 watts output, but frequencies over 45 kHz are restricted to 1 watt. Using direct connection and the higher power at the low frequencies helps significantly in achieving greater location distances. Direct connections should not be made to cables carrying greater than 25V (or as your safety practices allow). The transmitter is protected (250V fuse) from stray currents that may exist on the target line.

7.3.3 Clamp Mode

Plugging the signal clamp supplied by Vivax-Metrotech into the output socket will place the transmitter in "Clamp" mode. An icon confirming this is displayed on the display. The icon flashes when the transmitter is transmitting. When using the clamp no ground connection is needed.

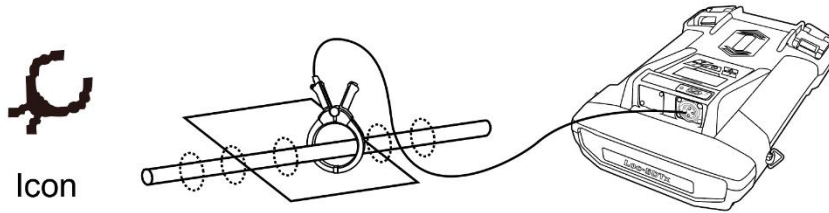

The clamp again is a precise way to apply the locating signal. It is generally used when access to the conductor cannot be achieved to make a direct connection (but there is sufficient access to place the clamp around the cable), or when it is not safe to make a direct connection because the target cable is carrying electricity.

The clamp is a specialized inductive device (sometimes known as a toroid or coupler). All clamps are optimized to work at specific frequencies. In most cases clamps are designed to be used at frequencies generally between 8 kHz and 83 kHz. The transmitter will only allow the selection of a suitable range of frequencies for your clamp.



WARNING

When applying the clamp to cables that carry electricity – be sure to follow your company's safety instructions and procedures. Beware that if applied around a high voltage cable – that cable may induce a current in the clamp causing it to snap shut or jump quite dramatically – always apply clamps carefully.

7.4 Frequencies

7.4.1 Frequencies and Power Output

The Loc-5STx transmitter is supplied with a predefined set of transmit frequencies. The most commonly used frequencies are preset by the factory. Additional frequencies can be added from the frequency select list. (See section 7.4.2 for access to this menu).

Example of standard frequencies/preset at the factory are:

- 512Hz (where electrical systems are 60Hz) direct connection – 5-watts.
- 640Hz (where electrical systems are 50Hz) direct connection – 5-watts.
- 8 kHz direct connection – 5-watt.
- 33 kHz direct connection – 5-watt.
- 65 kHz direct connection – 1-watt.
- 83.1 kHz, 131 kHz direct connection – 1-watt (depending on region).
- 200 kHz direct connection – 1-watt (depending on region).
- Some other frequencies with 5-watt output:
 - Direction connection: 256Hz, 491Hz, 982Hz, etc.
 - Direct and clamp connection: 8.19 kHz, 8.44 kHz, 9.5 kHz, 9.82 kHz, 32.8 kHz, 38 kHz.
- Some other frequencies with 1-watt output: 89 kHz, 131 kHz, 200 kHz.
- Clamp connection: any frequency from 8 kHz up to the highest allowed frequency (depending on region).
- Induction Frequency: this transmitter is a broad-band induction unit. It means that user can select for the Induction mode any frequency he wants, from 8 kHz up. (highest available frequency depends on region).

NOTE: see section 7.4.2 for frequency activation procedure.

7 Loc-5STx Transmitter

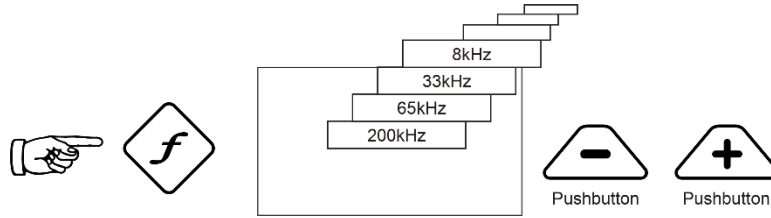

As with most manufacturers the clamps and induction antennas are tuned to specific frequencies, and **do not** work over the complete range of frequencies.

Frequencies are selected by pressing the "f" pushbutton which toggles through the available frequencies for the selection mode. The frequency is automatically selected if you don't toggle past it within two seconds. The frequency is shown on the display.

NOTE:

The output current is shown in large characters on the display – to increase or reduce the power output press "+" or "-". The vertical bar graph at the bottom of the display indicates which of the five current output steps is being used. If the transmitter can supply the requested current, the bar will turn black. If the bar does not turn black, improving the ground connections or wetting the ground where the earth stake is positioned, may help. However, it may not be able to achieve the current setting requested because the impedance of the line is too high for this setting. If this happens it is best to select a setting that has a black bar, this will ensure a stable output.

The current being transmitted will be limited by the impedance of the cable, therefore it is not unusual to increase the output level, but see no increase in the current displayed. This is not a fault with the transmitter.

The transmitter will always revert to first level output when switched on – this is a power saving feature – in most circumstances this output level is sufficient. Increasing the output power unnecessarily will reduce the battery life unnecessarily. All other settings remain the same as the last setting used.

7.4.2 Most Used Frequencies (Frequency Selection) Feature

This feature can be used to allow the operator to choose their most used frequencies from a list of possible frequencies. Once these frequencies are selected in the main menu, pressing the "f" pushbutton, user can scroll through them. At any time the user can add or remove frequencies from the above list, following the below procedure. Maximum frequencies that can appear in most used frequencies list is 12.

The advantage of this feature is that user can optimize the transmitter and activate at the main menu the user's preferred frequencies, instead of having a whole list of frequencies the user has to scroll through.

To enter the "Frequency Menu" proceed as follows:

1. Press the "i" pushbutton four--six times (based on the mode that transmitter is in), until you get to the "Frequency menu" sub-menu.

In Direct Connection mode,

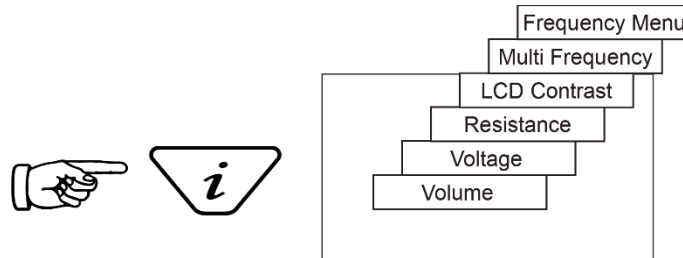

7 Loc-5STx Transmitter

In SD mode,

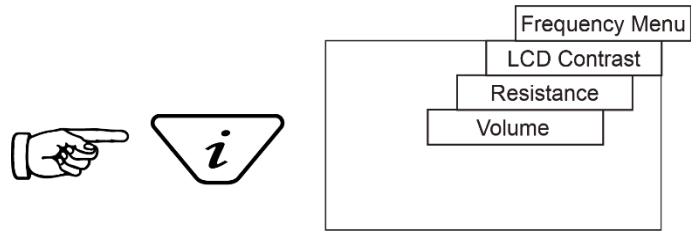

In Clamp mode,

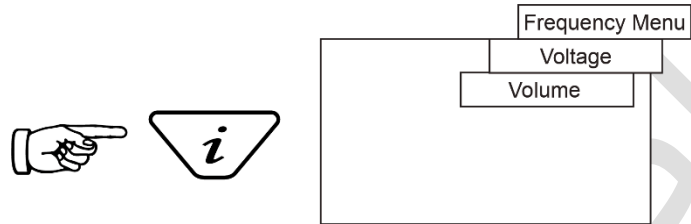

- The screen will show a list of frequencies available, with the central one in a box.

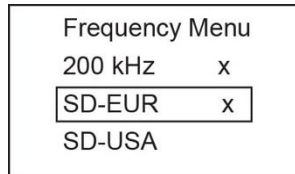

- Pressing the " \ominus " or " \oplus " pushbuttons, you can scroll up or down through the available frequencies.
- Once the preferred frequency is inside the box, press "f" pushbutton to select or deselect the frequency. An "x" will appear in the box for a selected frequency.

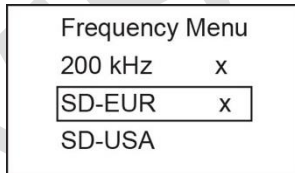

- After selecting the frequencies, press the "i" pushbutton again to exit the "Frequency Menu" and return to the main display.
- A particular frequency in the chosen list of frequencies can be selected from the main display screen by pressing the "f" pushbutton until the wanted frequency is displayed at the top of the main screen.

7.4.3 Multi-Frequency Mode for Direct Connection

This feature can be used when the user wants to energize on target two/three frequencies at the same time. Mainly, it can be used when user is not sure which frequency can be impressed better into the target. Multi frequency mode is not available in Fault Find and SD modes.



NOTE

- When using multi-frequency mode, total power will be split between the activated frequencies.
- The frequencies have to be available in the main menu.

To enter the "Multi-Frequency Setup" menu, proceed as follows:

- Press "i" pushbutton four times to get to the "Multi-Frequency" screen and press "f" pushbutton to activate the multi-frequency mode. An "x" symbol will appear indicate the multi-frequency mode is activated. Press "f" pushbutton again to go in "Multi-Frequency Setup" screen to choose the frequencies.

7 Loc-5STx Transmitter

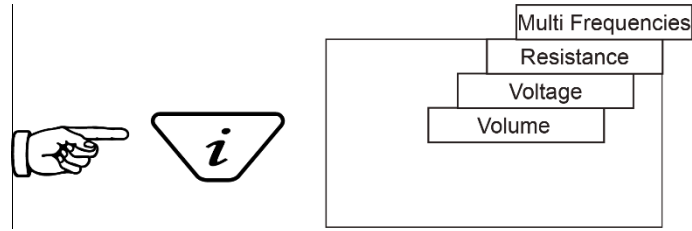

2. Press the " \triangleleft " and " \triangleleft " pushbuttons to scroll through the available frequencies, and bring the wanted one in the first box.

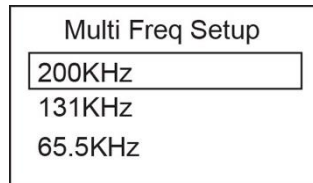

3. Press "f" pushbutton to move the box down and the " \triangleleft " and " \triangleleft " pushbuttons to select the second frequency.

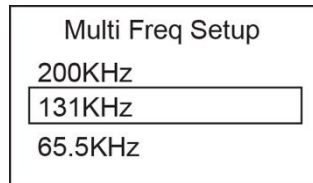

4. Repeat step three to select the third frequency if needed.
5. Press "i" pushbutton to return to main display. On the main display, "Multi" will appear indicating the multi-frequency mode is active.

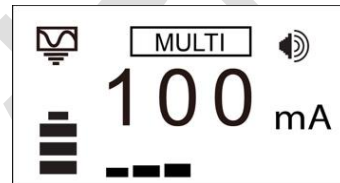

6. The frequencies selected for multi-frequency mode will be saved until changes are made even when the multi-frequency mode is deactivated.

7.5 Transmitter Battery

7.5.1 Replacing Alkaline Batteries

- Replace with new batteries of the same type, be sure not to mix old and new batteries.
- **Do not** use rechargeable batteries in the alkaline battery tray. Ensure that batteries are inserted the correct way (see label " \triangleleft " and " \triangleleft " on the side of the tray).
- Refit the battery tray, place it inside the housing and close the battery cover.



WARNING
Alkaline Batteries – insert alkaline batteries (x8) as shown.

7.5.2 Rechargeable Batteries

- **Do not** attempt to replace the rechargeable batteries or remove battery covers – return to Vivax-Metrotech or a Vivax-Metrotech approved service center for replacement.



WARNING
Only use the Vivax-Metrotech recommended charger.



WARNING
Charging socket



Two pins are used for power in from charger (to charge rechargeable batteries).



NOTE
Rechargeable pack cannot be charged from a 12V DC source.

Contact Vivax-Metrotech or a Vivax-Metrotech approved service center for wiring diagram of plug, if attempting to repair any of the “charging” leads.

7.5.3 Battery Charging and Disposal

Follow instructions detailed in the General Safety & Care portion of this document.

Only use the charger supplied with the equipment. Using an unapproved battery charger may damage the batteries and cause overheating.

The charger is mains operated. Connect the charger to the battery pack at the rear of the transmitter. The LED on the charger will show a red light indicating that the charge process has started. When the LED changes to a green indicator the charge sequence is complete and the batteries will be fully charged.

8. Using the Accessories

8.1 Using the LPC Separation Filter



The LPC separation filter (LPC) is used to safely inject a trace tone to a live cable via a domestic mains socket, so that the cable can be traced from the premises to the connection in the street. It is suitable for connecting to voltages up to 250V AC.

Method:

1. Plug the LPC into the output socket of the transmitter.
2. Identify a suitable main socket. If a switch is fitted to the socket, switch off. Plug in the LPC to the mains socket and then switch back on.
3. Set the LPC rotary switch to match the two indicator lights.
4. Set the transmitter to the frequency to be located.(8 kHz or 32 kHz are good frequencies for this application).
5. Set the output to mid-range.

8.2 Using the Analogue A-frame Fault Finding Accessory



The analogue A-frame accessory is used to detect ground faults on pipes and cables. In the case of pipes, the faults consist of coating defects. In the case of cables, faults are usually caused by insulation damage allowing the metallic sheath (or internal conductor) to become in contact with the ground.

It is intended to be used with the vLoc3-Pro range of locators and will require a fault find signal applied to the faulty conductor from a Vivax-Metrotech compatible transmitter.

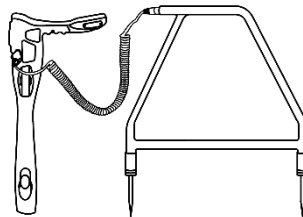

Fault finding requires a non-standard signal "8kHz FF" (Or FF fault find signal but ensure the Rx and Tx settings are matched)

8 Using the Accessories

To detect a damaged section, the line should be isolated and have all ground bonding removed. This will ensure that the ground fault is not masked by deliberate bonding to ground. The A-frame cannot distinguish between these two situations.

After isolating the line, use the transmitter resistance measuring function, or a dedicated resistance measuring device to confirm that there is a fault to ground. The A-frame will typically detect faults up to 2 Mohm (depending on the distance from transmitter, soil conditions etc).

A ground stake needs to be pushed into the ground and the black cable clipped to it. Try to place the ground stake as far as possible from the line to be evaluated. This ensures return currents do not distort the results.

Always connect the ground stake first when connecting up and last when disconnecting. Make the connections before switching on as hazardous voltages can be present on the connection clips.

Connect the transmitter to the target line using the red lead. Switch on the transmitter and select either 8kFF low or 8kFF high. Use 8kFF high if the line to be surveyed is long or the fault resistance is high. Make sure the receiver and transmitter are set for the same FF type, i.e. 8kFF.

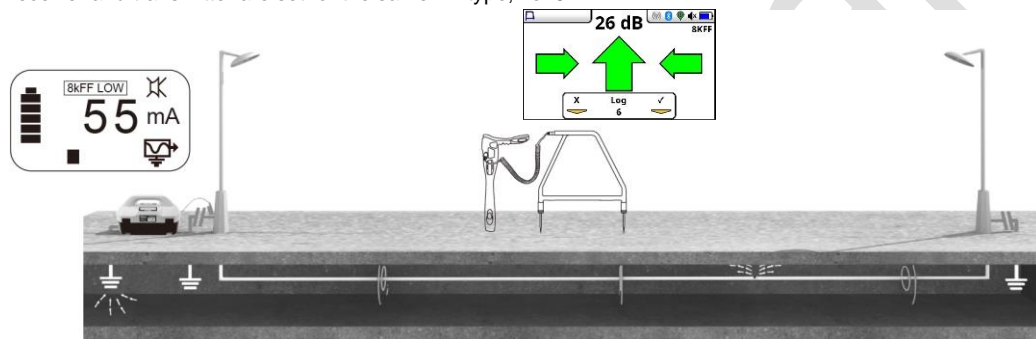

Plug in the A-frame to the receiver accessory socket. When the receiver is switched on, it will automatically default to the A-frame screen.

Note also the Auto shutdown setting will be set to “Never shutdown” when the A frame is attached.

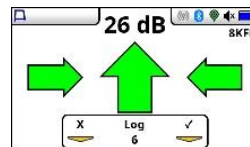
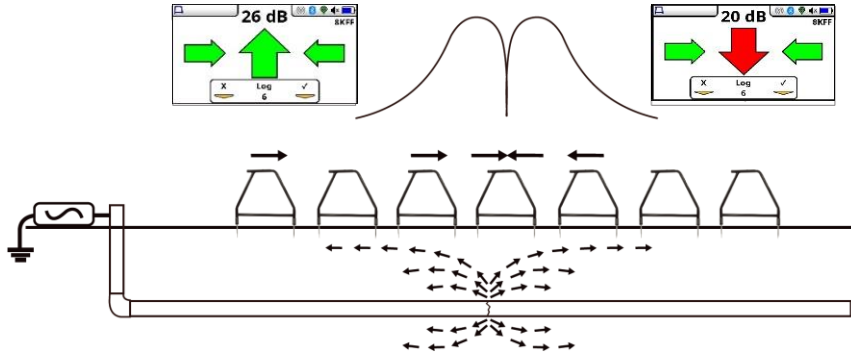

Image for reference only and may differ from actual image

Remove the plastic spike covers from the A-frame. Walk along the route of the line placing the spikes of the A-frame in the ground (with the green leg pointing away from the transmitter connection point) every two or three paces.

If starting near the transmitter, the arrow on the display will point away from the ground point. As the distance from the transmitter increases, the dB reading will reduce and eventually the arrow will fluctuate or disappear altogether. This is because the fault location is further along the line. Use the left/right arrows to ensure the A-frame is positioned over the line and continue placing the A-frame in the ground every two or three paces. If necessary, use the “M” pushbutton to enter the locate screen allowing the user to confirm the position of the target line. Press the “M” pushbutton again to re-enter the A-frame mode.

8 Using the Accessories



(Note that the A-frame is not shown connected to the receiver so as to simplify the diagram).

Eventually, the A-frame will detect the fault signal and the “Fault Find” arrow will point forward. Continue moving forward, it may be worth reducing the distance between measurements points as the fault is neared. The dB reading will increase as the fault is neared. Maximum reading will be just before and just after the fault. When over the fault, the dB reading will drop and the arrow will flip backwards indicating that the position of the fault has been passed.

Carefully place the A-frame before and after the fault to pinpoint the position. Repeating this across the line direction will pinpoint the fault laterally. The fault will be at the point where the lateral fault is identified.

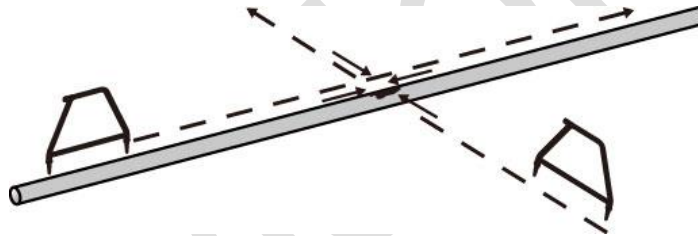

WARNING

Always disconnect or isolate target/faulty/suspected cables before connecting the transmitter to it. Never attach the transmitter to live cables.



TIP

If it is suspected that there is just one fault, insert the A-frame approximately one meter from the earth stake. Note the dB reading - this is approximately the maximum dB reading that will be measured over the fault.

A-frame Datalogging.

Data logging is possible when the A-frame is connected. Make sure the A Frame is located in the desired position with the pins firmly inserted in the ground.

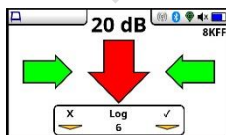

To record data press the “+” button. The soft key on the display will momentarily go green indicating that the data is stored, and the Log number will increment.

The data log can also be deleted from the Info screen. From the A-frame screen press and hold the “-” key. The message below will be shown.

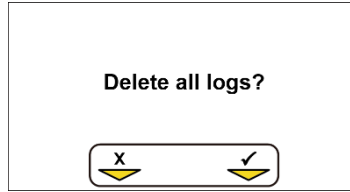

Press the "+" key to confirm. The locator will ask again "Are you sure?". Press the "-" key to delete or the "+" key to cancel the deletion and return to the locate/accessory screen.

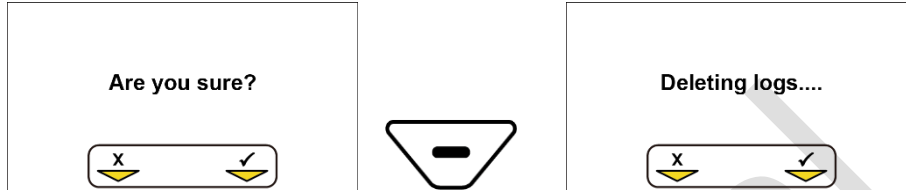

8.3 Using the vLoc3-Pro Remote Antenna



The remote stethoscope antenna can be used to help trace a particular cable on a cable tray or where cables are bunched together.

Methods:

1. Connect a signal to the cable to be identified. The remote stethoscope functions has an operational frequency range of 512Hz up to 200 kHz, but low frequencies should be a preference in this application as they are less likely to leak or bleed over to other cables.
2. When cables are earth bonded together and the cross bonds cannot be removed, the best method of signal application is to use the signal clamp. This is because the signal clamp applies a signal to the target cable and shares an equal amount with other cross bonded cables.

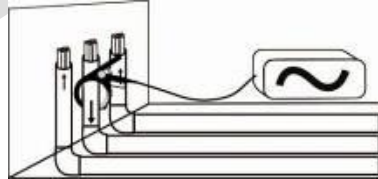

3. When using the signal clamp, it is best if both ends of the target cable are grounded. Apply the clamp below the ground point. Applying the clamp above the ground point will prevent the signal finding the return path through the ground, so this is not advised.



8 Using the Accessories

4. If it is not possible to use a transmitter signal clamp, and you have confirmation that the cable is out of service, use a direct connection lead to make an electrical connection to the cable. Removing any cross bonding between cables prevents the signal travelling along commonly bonded cables.

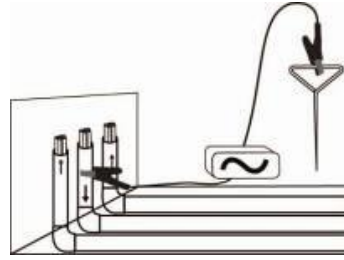

5. It is best NOT to use Induction method as the signal will appear on all cables in the area of the transmitter.
6. Connect the remote stethoscope antenna to the accessory input of the receiver. The correct settings and user interface will be automatically selected.

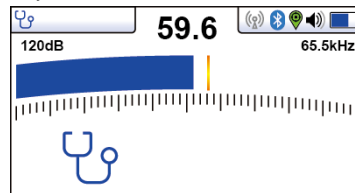

7. Ensure the frequency selected on the vLoc3-Pro is the same as selected on the transmitter.
8. Place the stethoscope on each of the suspected target cables, if possible part each one from the bunch before each test, with the flats of the antenna in line with the route of the cable.

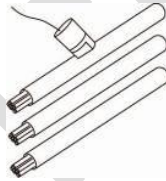

9. Note the signal reading of each cable. The one with the largest reading is likely to be the target cable. If necessary, adjust the sensitivity of the vLoc so that the signal is within the operating section of the bar graph.



WARNING

The remote stethoscope antenna is a useful tool to help trace cables. However, it should not be used as positive identification before an unused cable is cut. Always follow company procedures when cutting disused or isolated cables.



TIP

The remote stethoscope antenna can be used to help identify disused and isolated cables. This process can be further enhanced if the cable is isolated and is of a twisted cable construction.

Method:

1. Connect the transmitter to two of the cores of the cable. At the far end, short together these two conductors making a loop.
2. Set the transmitter to a low frequency such as 640Hz and set the output to maximum.

8 Using the Accessories

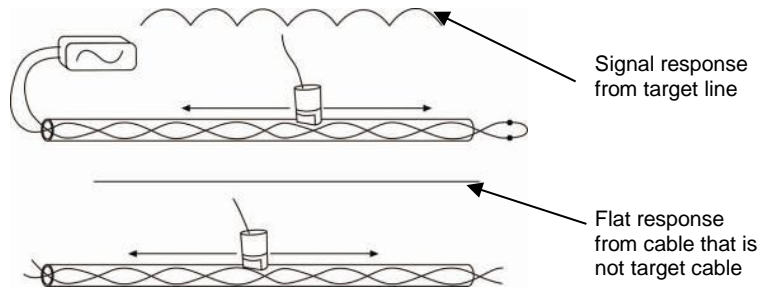

3. At the point of interest, if possible part the suspected cable from the bunch then run the remote stethoscope antenna along the suspected target cable keeping the flat portions of the antenna in line with the cable. If the correct cable is being assessed the signal will increase and decrease in sympathy with the twist of the two conductors within the cable.
4. If the signal is a steady level and does not rise and fall, this is probably **not** the target cable.



WARNING

The remote stethoscope antenna is a useful tool to help trace cables. However, it should **NOT** be used as positive identification before an unused cable is cut. Always follow company procedures when cutting unused or isolated cables.

8.4 Using the SD Signal with the Remote Antenna to help trace a particular cable

The Remote Antenna is also capable of detecting SD signals. SD is described earlier in section 4.11.

Method:

1. Apply the signal using the direct connection method. Remember to isolate the cable beforehand as below. It is also preferable to use the ground stake as an independent ground. Using the station ground may result in multiple signals as the signal will return along commonly bonded cables.

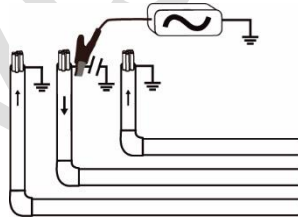

2. Select an SD signal from the transmitter (either SD-USA or SD-EUR).
3. Connect the remote antenna accessory to the locator and place it on the red lead of the transmitter with the arrow pointing away from the transmitter and with the flats of the antenna along the line of the cable.



4. Select the frequency using the "f" button so that it matches the selection on the transmitter. The screen should look similar to the below picture.

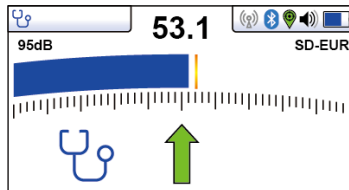

5. If necessary adjust the sensitivity so that the bar graph is on scale. Note that the green arrow is pointing forwards, this indicates that the signal is flowing forward. If the arrow was red and pointing backwards as below, it will be necessary to perform an SD reset before proceeding. However, if in doubt always perform

8 Using the Accessories

the reset to be sure the antenna and receiver are synchronized.

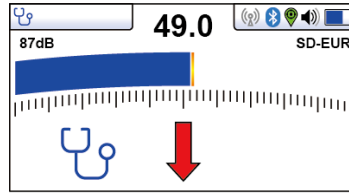

Performing a remote antenna SD reset

Connect the transmitter to the service to be identified, place the antenna on the red cable as previously described with the label pointing away from the transmitter.



Press the "M" button. The screen will change to something similar to the below.

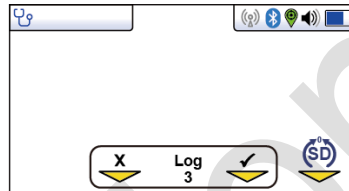

Press the "M" button as indicated by the "SD" icon. The screen will then revert to the one below with the arrow pointing forward. This indicates that the reset was successful.

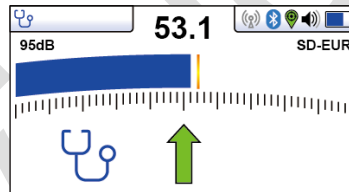

The system is now ready to identify the cable at the location of the interest.

Identifying a cable

Having confirmed the antenna is synchronized with the receiver, proceed to the location the cable is to be identified. Place the antenna on each of the suspected cable in turn ensuring the correct orientation, ie the arrow on the antenna pointing away from the transmitter.

Note the signal strength on each cable and also which arrow is illuminated. The target cable will have the strongest signal and will have the green forward arrow illuminated.

Enhancing the loopback method of cable identification with the aid of the SD signal

As described before, a more reliable method of loop backing the signal on the cable is possible if the cable is out of service. This method can be further enhanced with the aid of the SD signal.

Method:

Set up the transmitter as below, with the far end connected together and with the transmitter connected across a twisted pair of cable. Set the transmitter to SD EUR or SD USA and perform an SD reset as described above.

At the location of interest, hold the antenna on each of the cables in turn. Run the antenna along the cable keeping the arrow on the antenna pointing forwards. On the incorrect cable the signal level will be small and steady. On the correct target cable the signal will rise and fall in sympathy with the twist in the cable. Also, if on the target cable, at alternate peaks the arrows will switch from forward to backward pointing.

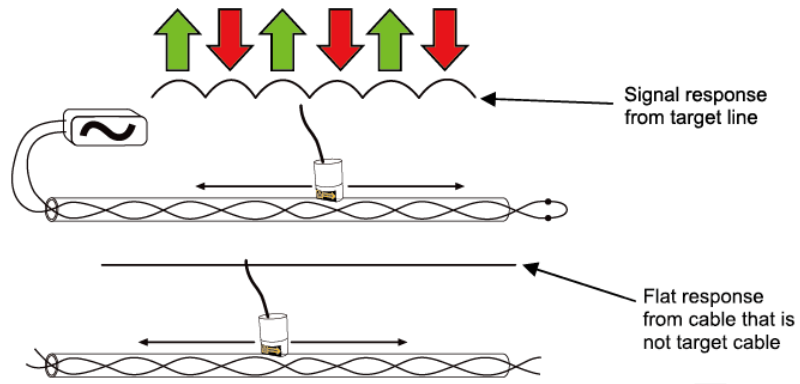

WARNING

The remote stethoscope antenna is a useful tool to help trace cables. However, it should not be used as positive identification before an unused cable is cut. Always follow company procedures when cutting disused or isolated cables.

9. Accessories & Options

9.1 A-frame (Optional)



The A-frame accessory is used to detect ground faults on pipes and cables. In the case of pipes, the faults consist of coating defects. In the case of cables, faults are usually caused by insulation damage allowing the metallic sheath (or internal conductor) to become in contact with the ground.

9.2 Remote Antenna (Optional)



The remote antenna can be used to help identify a particular cable on a cable tray or where cables are bunched together.

9.3 Loc-10Tx Vehicle Power Lead (Optional)

12V DC, 30ft (10m) lead to power the transmitter from a vehicle.



If it is intended to apply the transmitter to a target line at high output levels and long periods, it may be useful to power the transmitter using the 12V DC vehicle power lead. To power the transmitter from the 12V DC vehicle power lead, connect the lead to the 12V DC input socket positioned on the side of the transmitter. Plug the cigarette lighter plug into the vehicle cigarette lighter socket (be sure that the socket is live. Some vehicles only activate the cigarette lighter when the vehicle is running).

It is not necessary to disconnect or remove the standard batteries as the unit will automatically select the external 12V DC supply.

9.4 Loc-10Tx Outdoor Power Supply (Optional)



23V DC, 30ft (10m) lead to power and charge the transmitter from the mains supply.

9.5 LPC Separation Filter (Optional)



The LPC separation filter (LPC) is used to safely inject a trace tone to a live cable via a domestic mains socket, so that the cable can be traced from the premises to the connection in the street. It is suitable for connecting to voltages between 100V AC and 250V AC.

9.6 Receiver Vehicle Charging Lead (Optional)



12ft (4m) long lead to charge the receiver's battery (Lithium-ion) while on the move.

It is preferable to connect the charger to a cigarette lighter socket that is permanently live. However, do **not** leave connected to the receiver for excessively long periods.

9.7 Sonde (Optional)



D18-33-SR44 Sonde

- 0.7in (18mm) x 3.2in (81mm) long, 33 kHz, range 15ft (4.5m).
- 2 x button cell batteries.

D38-33-AA Sonde

- 1.5in (38mm) x 4.1in (105mm) long, 33 kHz, range 16.3ft (5m).
- 1 x AA battery.

D38-09-AA Sonde

- 1.5in (38mm) x 4.1in (105mm) long, 9.8 kHz, range 16.3ft (5m).
- 1 x AA battery.

D38-83-AA Sonde

- 1.5in (38mm) x 4.1in (105mm) long, 83 kHz, range 16.3ft (5m).
- 1 x AA battery.

D64-33-LR61 Sonde

- 2.5in (64mm) x 7.3in (186mm) long, 33 kHz, range 26ft (8m).
- 1 x LR61 battery.

D64-09-LR61 Sonde

- 2.5in (64mm) x 7.3in (186mm) long, 9.8 kHz, range 26ft (8m).
- 1 x LR61 battery.

D64-83-LR61 Sonde

- 2.5in (64mm) x 7.3in (186mm) long, 83 kHz, range 26ft (8m).
- 1 x LR61 battery.

D23F-512-AA / D23F-640-AA Sonde

- 1in (23mm) x 18in (456mm) long, range 20ft (7m).
- "Flexible (3 section) Sonde with optional 512Hz or 640Hz for use in cast iron pipes".
- 1 x AA battery.

9.8 Clamp (Optional)



9 Accessories & Options

- VX2/50, VX4/100, VX5/125, VX18/450F
- Dia. 2in (50mm), Dia. 4in (100mm), Dia. 5in (125mm), 18in flexible (Circumference 450mm)

An accessory used to apply the transmitter signal to an insulated line, removing the need to connect the transmitter signal directly to a conductor or cable sheath.

9.9 Clamp Extension Rod



The extension rod is fitted with a 10mm screw thread. This male thread will screw into the handle of the signal clamp and will enable the clamp to be attached too hard to reach cables such as in manholes or overhead cables.

The extension rod is also fitted with a female thread in the handle which enables the rods to be fitted together to further extend the range. To access this thread the yellow handgrip needs to be slid off the end of the rod.

To operate the clamp jaws when attached to the rod, gently pull on the clamp cord which will open the jaws. Release to cable to close them.

9.10 Lithium-ion Rechargeable Battery Pack (Standard)



The Lithium-ion rechargeable battery pack is supplied as standard. Use the battery charger listed below to charge the battery pack. Charging is done with the battery inside the receiver.

9.11 Receiver Battery Charger (Standard)



The receiver Lithium-ion battery charger is supplied as a standard item. It is powered from the mains supply (100-250V AC).

9.12 USB Cable (Standard)



The USB cable is used to connect the receiver to a host computer so that software updates can be implemented and also for the transfer of data logs from the unit to a computer.

9.13 Alkaline Battery Holder (Standard)



This battery pack is supplied as standard and is used in the event the rechargeable battery pack has fully discharged. It can be considered as a backup battery pack. It requires 6 x AA alkaline batteries.

9.14 Ground Stake (Standard)



Used to make an independent connection to the ground so as to complete the circuit when the transmitter is connected to a line using the direct connection method.

9.15 Direct Connection Lead (Standard)



Used to connect the transmitter to a line using the direct connection method.

9.16 Ground Spool (Optional)



Used to extend the ground connection to a suitable grounding position.

9.17 Banana Plugs Adapter (Optional)



Adapts the direct connection crocodile clip to banana plug allowing the direct connection leads to be connected to a banana socket.

9.18 Loc-5STx Battery Pack (Li-Ion)



Li-Ion rechargeable battery pack. Only use the charger supplied as below.

9.19 Loc-5STx Alkaline Battery Tray



Requires 8 x Alkaline D cells.

9.20 Loc-5STx Charger



Mains charger (100-250V AC input) used to charge 5 Watt rechargeable battery packs. Supplied as standard with rechargeable battery option.

9.21 Loc-10Tx Charger



Mains charger (100-250V AC input) used to charge 10 Watt rechargeable battery packs. Supplied as standard with rechargeable battery option.

9.22 Loc-10Tx Rechargeable Battery Tray



NiMH rechargeable battery pack. Only use the charger supplied.

9.23 Loc-10Tx Alkaline Battery Tray





Requires 12 x Alkaline D cells.

9.24 Live Plug Connector (LCC)



For use on live cables up to 480V AC 60/50Hz. Operating frequencies: 8.192k Hz, 32.768k Hz, 8.44k Hz SIS. For best results, connect across a phase cable and independent ground.

10. Glossary

Active Locate	A locate where a transmitter is used to apply a signal to a buried pipe or cable, the position of which is then located by a receiver tuned to the same frequency.
Active Signal	A signal applied by the locator transmitter to a buried line. Typical this is a very precise frequency.
Attenuation	The reduction of an electromagnetic signal from a pipe or cable.
Clamp (or Coupler)	An accessory used to apply the transmitter signal to an insulated line, removing the need to connect the transmitter signal directly to a conductor or cable sheath.
Compass	Line direction indicator (although visually like a compass, this is the only relation to a compass.)
Coupling	The act of signals transferring to lines to which they were not originally applied. Coupling can be "direct" where the target line has an electrical connection to another line, or "induced" where the signal radiates from the target line to another line or lines.
Display	The information visually available on the dot matrix display.
Line	A generic term for any buried pipe or cable.
Null	A minimum response to a buried line. 
Passive Locate	A locate where the receiver searches for a wide range of signals that radiate from buried pipes or cables. These signals come from a variety of sources in the environment and couple to the buried (& overhead) lines. Typical examples 50 / 60Hz and LF/VLF radio.
Passive signals	A wide range of signals that radiate from buried pipes or cables. These signals come from a variety of sources in the environment and couple to the buried (& overhead) lines. Typical examples 50/60Hz and LF/VLF radio.
Peak	A maximum response to a buried line. 
Pinpoint	Using a receiver to identify the exact position of a buried line.
Response	The indication that the receiver gives, which is caused by the signals it is receiving. This can be visual, audio or both. Typically, it is displayed on the locators dot matrix display and audibly from a loudspeaker in the receiver housing.
Search (sweep)	This describes the act of looking for a buried line within a given area.
Sonde	A small transmitting coil which may be built into a product such as a sewer camera or packaged as a small self-contained battery powered transmitter. A receiver tuned to the same frequency can locate the position of the Sonde and hence whatever it is attached to or in. Frequently used for locating sewer cameras, and the nonmetallic pipes.

10 Glossary

Target Line	The buried pipe or cable to be located.
Trace	Using a locator to follow the path of a buried line.

Illustrations used in the preparation of this manual will inevitably show some resemblance to similar illustrations from other Manufacturers-some manufacturers have given permission for the use of their graphics (Vivax-Metrotech & Seba) is given credit for these use. This statement is intended to attribute such credit.

Disclaimer: Product and accessory specification and availability information is subject to change without prior notice.

Notes:

Provisional



VIVAX
METROTECH

Locators & Supplies, Inc.
(800) 950-6666
sales@locatorsandsupplies.com
www.locatorsandsupplies.com

VISIT US AT

www.locatorsandsupplies.com

LOCATORS



MARKING PRODUCTS



Measuring Devices



SAFETY CLOTHING

ARC Safety



GLOVES



First Aid



Repellants



PPE



Confined Space



Work Zone Safety



Lighting & Warning



Truck & Trailer Supplies



Truck Safety



Cable Installation Equipment



Hoist, Slings and Ropes



Compaction Equipment



TOOLS



Power Tools



Generators & Inverters



Building Maintenance



Safety Cans Cabinets & Signs



Erosion Fabric



Asphalt Tools



Electronic Meters & Cases



Email sales@locatorsandsupplies.com

1-800-950-6666